

SLP-WHG-TSN

8th Gen Intel® Core™ Processor Core™ SoC i7/i5/i3 &
Celeron® BGA Processor Fanless Expandable Slot PC with
TSN Gigabit Ethernet PCIe NIC Card

Quick Reference Guide

2nd Ed –12 July 2023

Copyright Notice

Copyright © 2023 Avalue Technology Inc., ALL RIGHTS RESERVED.

Part No. E2017NAM0A1R

FCC Statement



THIS DEVICE COMPLIES WITH PART 15 FCC RULES. OPERATION IS SUBJECT TO THE FOLLOWING TWO CONDITIONS:

- (1) THIS DEVICE MAY NOT CAUSE HARMFUL INTERFERENCE.
- (2) THIS DEVICE MUST ACCEPT ANY INTERFERENCE RECEIVED INCLUDING INTERFERENCE THAT MAY CAUSE UNDESIRE OPERATION.

THIS EQUIPMENT HAS BEEN TESTED AND FOUND TO COMPLY WITH THE LIMITS FOR A CLASS "A" DIGITAL DEVICE, PURSUANT TO PART 15 OF THE FCC RULES.

THESE LIMITS ARE DESIGNED TO PROVIDE REASONABLE PROTECTION AGAINST HARMFUL INTERFERENCE WHEN THE EQUIPMENT IS OPERATED IN A COMMERCIAL ENVIRONMENT. THIS EQUIPMENT GENERATES, USES, AND CAN RADIATE RADIO FREQUENCY ENERGY AND, IF NOT INSTALLED AND USED IN ACCORDANCE WITH THE INSTRUCTION MANUAL, MAY CAUSE HARMFUL INTERFERENCE TO RADIO COMMUNICATIONS.

OPERATION OF THIS EQUIPMENT IN A RESIDENTIAL AREA IS LIKELY TO CAUSE HARMFUL INTERFERENCE IN WHICH CASE THE USER WILL BE REQUIRED TO CORRECT THE INTERFERENCE AT HIS OWN EXPENSE.

A Message to the Customer

Avalue Customer Services

Each and every Avalue's product is built to the most exacting specifications to ensure reliable performance in the harsh and demanding conditions typical of industrial environments. Whether your new Avalue device is destined for the laboratory or the factory floor, you can be assured that your product will provide the reliability and ease of operation for which the name Avalue has come to be known.

Your satisfaction is our primary concern. Here is a guide to Avalue's customer services. To ensure you get the full benefit of our services, please follow the instructions below carefully.

Technical Support

We want you to get the maximum performance from your products. So if you run into technical difficulties, we are here to help. For the most frequently asked questions, you can easily find answers in your product documentation. These answers are normally a lot more detailed than the ones we can give over the phone. So please consult the user's manual first.

To receive the latest version of the user's manual; please visit our Web site at:

<http://www.avaluel.com.tw/>

Content

1. Getting Started	6
1.1 Safety Precautions	6
1.2 Packing List	6
1.3 System Specifications	7
1.4 System Overview.....	10
1.4.1 SLP-WHG Rear View	10
1.5 System Dimensions.....	11
1.5.1 SLP-WHG Front & Top view	11
2. Hardware Configuration	12
2.1 SLP-WHG connector mapping	13
2.1.1 Serial Port 1/2 connector (COM1/2).....	13
2.1.2 Serial Port 3/4 connector (COM3/4).....	13
2.2 EMX-WHLGP Overviews.....	14
2.2.1 EMX-WHLGP	14
2.3 EMX-WHLGP Jumper & Connector list	15
2.4 EMX-WHLGP Setting Jumpers & Connectors	17
2.4.1 Serial port 1/2 pin9 signal select (JCOM1-RI-RS485)	17
2.4.2 Serial port 1/2 pin9 signal select (JCOM2-RI-RS485)	17
2.4.3 LVDS Back Light power selection (JSBKL1)	18
2.4.4 AT/ATX Power Mode Select (JSATX1).....	18
2.4.5 Clear CMOS (JCMOS1).....	19
2.4.6 LCD Inverter connector (JBKL1).....	19
2.4.7 Serial port 1 connector (COM1)	20
2.4.8 Serial port 2 connector (COM2)	20
2.4.9 General purpose I/O connector (DIO1).....	21
2.4.10 SPI connector (JSPI1).....	21
2.4.11 Serial port 3-6 connector (COM3-6).....	22
2.4.12 SATA Power connector (SPWR1).....	23
2.4.13 CPU Fan connector (JFAN1)	23
2.4.14 USB connector 1(USB1)	24
2.4.15 USB connector 2(USB2)	24
2.4.16 LVDS connector (LVDS1)	25
2.4.17 Front Audio connector (FAUD1).....	26
2.4.18 EC Debug (JEC_DEBUG).....	26
2.4.19 Battery connector (BAT1).....	27

SLP-WHG-TSN

2.4.20	PS/2 keyboard & mouse header (KB/MS)	27
2.4.21	Miscellaneous setting connector 1 (FPT1)	28
2.4.22	Miscellaneous setting connector 2 (FPT2)	28
2.4.23	LED indicator connector 1 (LED1)	29
2.4.24	LED indicator connector 2 (LED2)	29
2.4.25	LED indicator connector 3 (LED3)	30
2.4.26	Speaker connector (SPK1)	30
2.4.27	J12C connector (J12C1)	31
2.4.28	LPC connector (JLPC1)	31
2.4.29	CPU Heatsink Heater Connector (JHT1/2/3/4/5/6)	32
2.4.30	LED Indicator for Heater (JHT_LED1)	32
2.4.31	Gold Finger (GF)	33
2.4.32	Power connector (PWR1)	35
3	BIOS Setup	36
3.1	Introduction	37
3.2	Starting Setup	37
3.3	Using Setup	38
3.4	Getting Help	39
3.5	In Case of Problems	39
3.6	BIOS setup	40
3.6.1	Main Menu	40
3.6.1.1	System Language	41
3.6.1.2	System Date	41
3.6.1.3	System Time	41
3.6.2	Advanced Menu	41
3.6.2.1	CPU Configuration	42
3.6.2.2	Power & Performance	42
3.6.2.2.1	CPU - Power Management Control	43
3.6.2.2.1.1	Config TDP Configurations	43
3.6.2.2.2	GT - Power Management Control	44
3.6.2.3	PCH-FW Configuration	45
3.6.2.3.1	Firmware Update Configuration	46
3.6.2.4	Trusted Computing	46
3.6.2.5	ACPI Settings	47
3.6.2.6	IT8528 Super IO Configuration	47
3.6.2.6.1	Serial Port 1 Configuration	48
3.6.2.6.2	Serial Port 2 Configuration	49
3.6.2.6.3	Serial Port 3 Configuration	49
3.6.2.6.4	Serial Port 4 Configuration	50
3.6.2.6.5	Serial Port 5 Configuration	50

3.6.2.6.6	Serial Port 6 Configuration.....	51
3.6.2.7	EC 8528 HW monitor.....	51
3.6.2.8	S5 RTC Wake Settings.....	52
3.6.2.9	Serial Port Console Redirection.....	52
3.6.2.9.1	Legacy Serial Redirection Port.....	53
3.6.2.10	USB Configuration.....	53
3.6.2.11	NVMe controller and Drive information.....	54
3.6.2.12	Network Stack Configuration.....	55
3.6.3	Chipset.....	55
3.6.3.1	System Agent (SA) Configuration.....	56
3.6.3.1.1	Memory Configuration.....	56
3.6.3.1.2	Graphics Configuration.....	57
3.6.3.2	PCH-IO Configuration.....	57
3.6.3.2.1	PCI Express Configuration.....	58
3.6.3.2.1.1	PCIe Root Port 8(LAN2-I210).....	58
3.6.3.2.1.2	PCIe Root Port 9(LAN3-I210/GF slot).....	59
3.6.3.2.1.3	PCIe Root Port 10(M.2 KeyA).....	60
3.6.3.2.1.4	PCIe Root Port 11(M.2 KeyB/SATA0).....	61
3.6.3.2.1.5	PCIe Root Port 13(GP PCIe4).....	62
3.6.3.2.2	SATA And RST Configuration.....	63
3.6.3.2.3	HD Audio Configuration.....	64
3.6.3.3	Board & Panel Configuration.....	64
3.6.4	Security.....	65
3.6.4.1	Secure Boot.....	66
3.6.4.1.1	Restore Factory Keys.....	66
3.6.4.1.2	Reset To Setup Mode.....	67
3.6.4.1.3	Key Management.....	67
3.6.5	Boot.....	68
3.6.6	Save and Exit.....	68
3.6.6.1	Save Changes and Reset.....	69
3.6.6.2	Discard Changes and Reset.....	69
3.6.6.3	Restore Defaults.....	69
3.6.6.4	Launch EFI Shell from filesystem device.....	69

1. Getting Started

1.1 Safety Precautions

Warning!



Always completely disconnect the power cord from your chassis whenever you work with the hardware. Do not make connections while the power is on. Sensitive electronic components can be damaged by sudden power surges. Only experienced electronics personnel should open the PC chassis.

Caution!



Always ground yourself to remove any static charge before touching the CPU card. Modern electronic devices are very sensitive to static electric charges. As a safety precaution, use a grounding wrist strap at all times. Place all electronic components in a static-dissipative surface or static-shielded bag when they are not in the chassis.

1.2 Packing List

- 1 x SLP-WHG Onboard 8th Gen Intel® Core™ SoC i7/i5/i3 & Celeron® BGA Processor with TSN PCIe card
- Other major components include the following:
 - Screw kit
 - Wall Mount Kit
 - Accessory box



If any of the above items is damaged or missing, contact your retailer.

1.3 System Specifications

System Information	
Processor	Onboard 8th Gen Intel® Core™ SoC i7/i5/i3 & Celeron® BGA Processor (Whiskey lake-U Series)
System Memory	2 x 260-pin DDR4 2133 MHz SO-DIMM socket, supports up to 32GB Max (non ECC only)
BIOS Information	AMI uEFI BIOS 256 Mbit SPI Flash ROM
Watchdog Timer	H/W Reset, 1sec. ~ 65535sec.
H/W Status Monitor	Monitoring CPU & System Temperature and Voltage
TPM	Onboard TPM 2.0
SBC	EMX-WHLGP
Expansion	
M.2 (Key-X, Size, Signal)	1 x M.2 Key-A 2230 for Wi-Fi & BT Module 1 x M.2 Key-B 3042/2242/2260/2280, support SATA 3/PCIe III x 1/USB 2.0 and internal SIM slot 1
PCIe (Gen X, Lanes)	1 x PCIe*1 slot 1 x PCIe*4 slot w/ASIX TSN Card: Quad Port TSN Gigabit Ethernet PCIe NIC Card
Storage	
M.2 (Key-X, Size, Signal)	1 x M.2 Key-B 3042/2242/2260/2280, support SSD (share with expansion slot)
2.5" Drive Bay (Height)	1 x 2.5" Drive Bay (internal)
Edge I/O (Front)	
USB Port	3 x USB3.1 Gen1 1 x USB Type C w/o ALT mode
COM Port	4 x RS-232
HDMI	2 x HDMI 3840 x 2160 @ 30 Hz, 1 x HDMI 2560 x 1600 @ 30 Hz
Audio	Line-Out, Mic-in
LAN Port	3 x RJ-45
TSN Port	4 x TSN Gigabit Ethernet
PS/2 KB & Mouse	1 x PS/2 Keyboard 1 x PS/2 Mouse
Power Button	1 x Power On/Off
Wire-Control Power On/Off	2-Pin Terminal Block

SLP-WHG-TSN

LED Indicator	1 x HDD LED 1 x Power LED
Antenna	Optional: 2 x Wireless LAN Antenna
Display	
Graphic Chipset	Intel® Processor Graphics
Resolution	HDMI :2 x 3840 x 2160 @ 30 Hz, 1x 2560 x 1600@ 30 Hz
Audio	
Audio Codec	Realtek ALC888S
Ethernet	
LAN Chipset	1 x Intel® I219-LM 2 x Intel® I210-IT
Power Requirement	
DC Input	DC in +12V ~ +24V), wide voltage
DC Input Connector	3-Pin Terminal Block (V+, V-, GND)
Power Mode	AT/ATX (ATX is default setting)
Adapter	24V/7.5A AC/DC 180W adapter (Phoenix connector), Optional
Mechanical & Environment	
Operating Temp.	-20~50°C (-4°F ~ 122°F) w/Industrial SSD and memory, ambient w/ 0.5m/s air flow
Storage Temp.	-40°C ~ 75°C (-40 ~ 167°F)
Operating Humidity	40°C @ 95% Relative Humidity, Non-condensing
Dimension (W*L*H)	217 mm x 115 mm x 220 mm
Weight	2.6 kg (System) 3.4 kg (w/Package)
Vibration Test	<p>Random Vibration Operation:</p> <ol style="list-style-type: none"> 1. PSD: 0.03622G²/Hz, 1.5 Grms 2. operation mode 3. Test Frequency: 5-500Hz 4. Test Axis: X,Y and Z axis 5. 30 minutes per each axis 6. IEC 60068-2-64 Test: Fh 7. Storage: SSD <p>Sine Vibration test (Non-operation)</p> <ol style="list-style-type: none"> 1 Test Acceleration : 2G 2 Test frequency: 5~500 Hz 3 Sweep : 1 Oct/ per one minute. (logarithmic) 4 Test Axis: X,Y and Z axis 5 Test time :10 min. each axis

	<p>6 System condition : Non-Operating mode</p> <p>7. Reference IEC 60068-2-6 Testing procedures</p> <p>Package vibration test</p> <ol style="list-style-type: none"> 1. PSD: 0.026G²/Hz, 2.16 Grms 2. Non-operation mode 3. Test Frequency : 5-500Hz 4. Test Axis: X,Y and Z axis 5. 30 min. per each axis 6. IEC 60068-2-64 Test: Fh
Shock Test	<ol style="list-style-type: none"> 1. Wave form : Half Sine waves 2. Acceleration Rate : 10g for operation mode 3. Duration Time : 11ms 4. No. of Shock : Z axis 300 times 5. Test Axis: Z axis 6. Operation mode 7. Reference IEC 60068-2-29 Testing procedures <p>Test Eb : Bump Test</p>
Drop Test	<p>Package drop test</p> <ol style="list-style-type: none"> 1. One corner, three edges, six faces 2. ISTA 2A, IEC-60068-2-32 Test: Ed
Software Support	
OS Information	Win10, Linux
Software Support	
Certification Information	CE/FCC Class A
In-Box Accessory	
Accessory	<ol style="list-style-type: none"> 1. 24V/7.5A AC/DC 180W Adapter 2. Wall mount kit 3. 2-pin terminal block



Note: Specifications are subject to change without notice.

1.4 System Overview

1.4.1 SLP-WHG Rear View

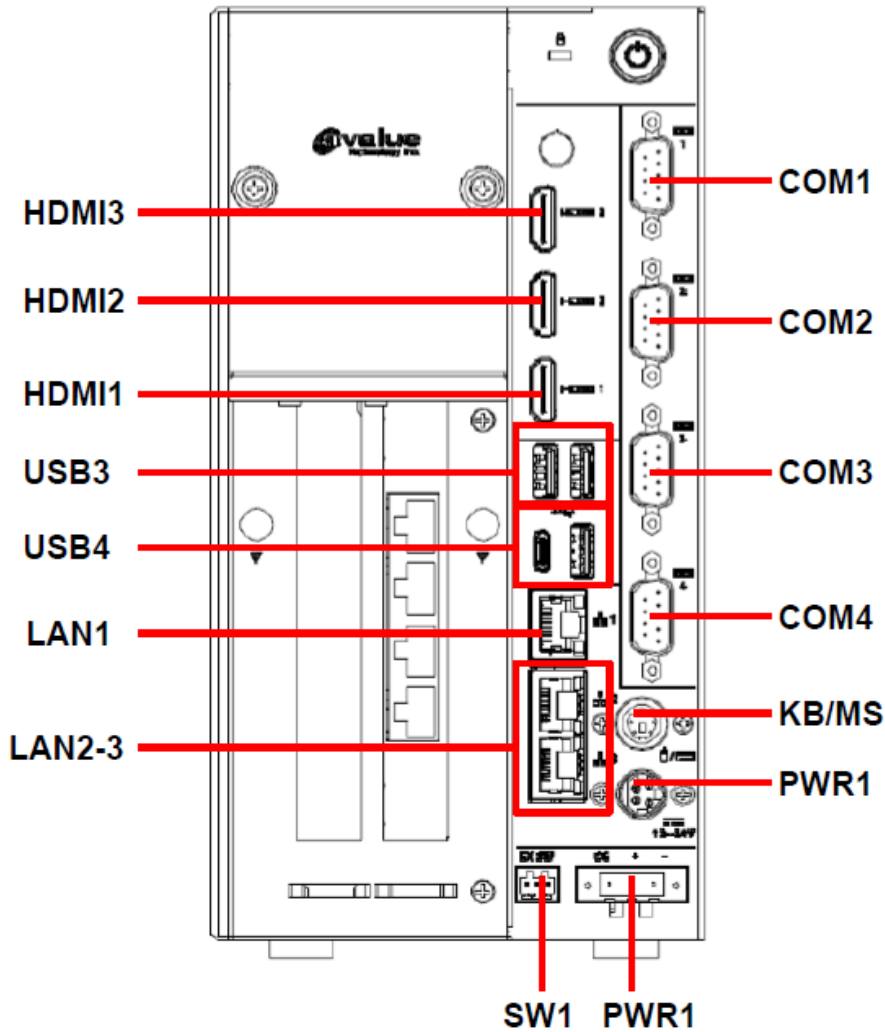

Connectors

Label	Function	Note
HDMI1/2/3	HDMI connector 1/2/3	
USB3/4	USB connector 3/4	
LAN1/2-3	RJ-45 Ethernet 1/2-3	
COM1/2	Serial Port 1 connector	5 x 2 header, pitch 2.00mm
COM3/4	Serial Port 3-6 connector	5 x 2 header, pitch 2.00mm
KB&MS	PS/2 keyboard & mouse header	4 x 2 header, pitch 2.00mm
PWR1	Power connector	2 x 2 wafer, pitch 4.20mm
PWR1	DC Input connector	3 x 1 wafer, pitch 5.08mm
SW1	Power Button connector	

1.5 System Dimensions

1.5.1 SLP-WHG Front & Top view

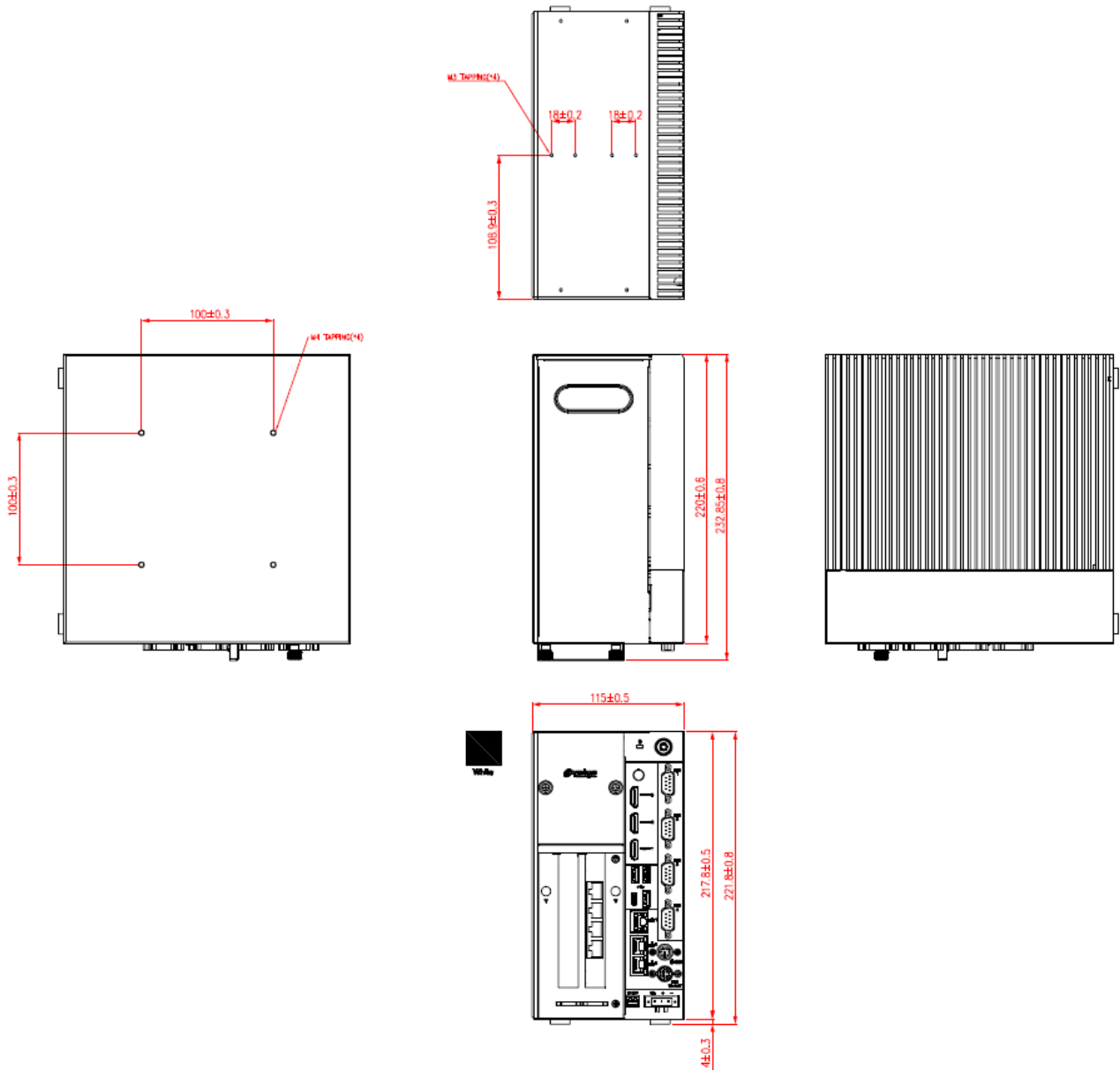

(Unit: mm)

2. Hardware Configuration

Jumper and Connector Setting

For advanced information, please refer to:

- 1- EMX-WHLGP User's Manual



Note: If you need more information, please visit our website:

<http://www.avalue.com.tw>

2.1 SLP-WHG connector mapping

2.1.1 Serial Port 1/2 connector (COM1/2)

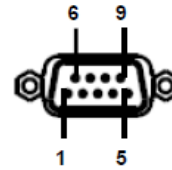
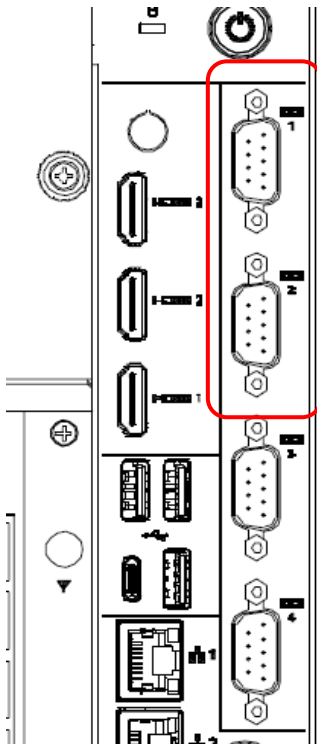

Pin	RS-232	RS-422	RS-485
1	DCD#	TXD422-	485DATA-
2	RXD	TXD422+	485DATA+
3	TXD	RXD422+	
4	DTR#	RXD422-	
5	GND		
6	DSR#		
7	RTS#		
8	CTS#		
9	RI#		

2.1.2 Serial Port 3/4 connector (COM3/4)

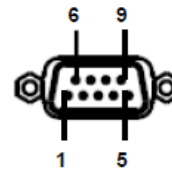
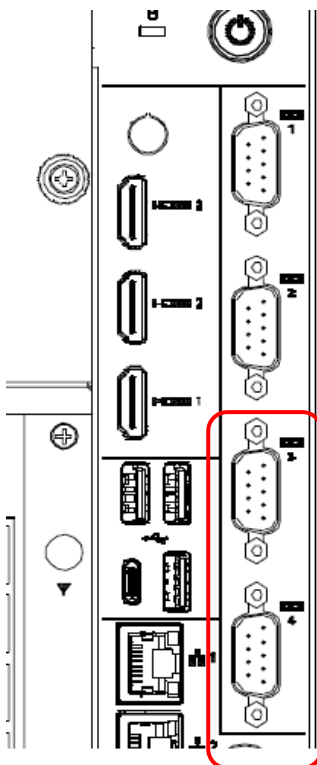

Signal	PIN	PIN	Signal
		9	NRI#
NCTS#	8	7	NRTS#
NDSR#	6	5	GND
NDTR#	4	3	NTXD
NRXD	2	1	NDCD#

2.2 EMX-WHLGP Overviews

2.2.1 EMX-WHLGP

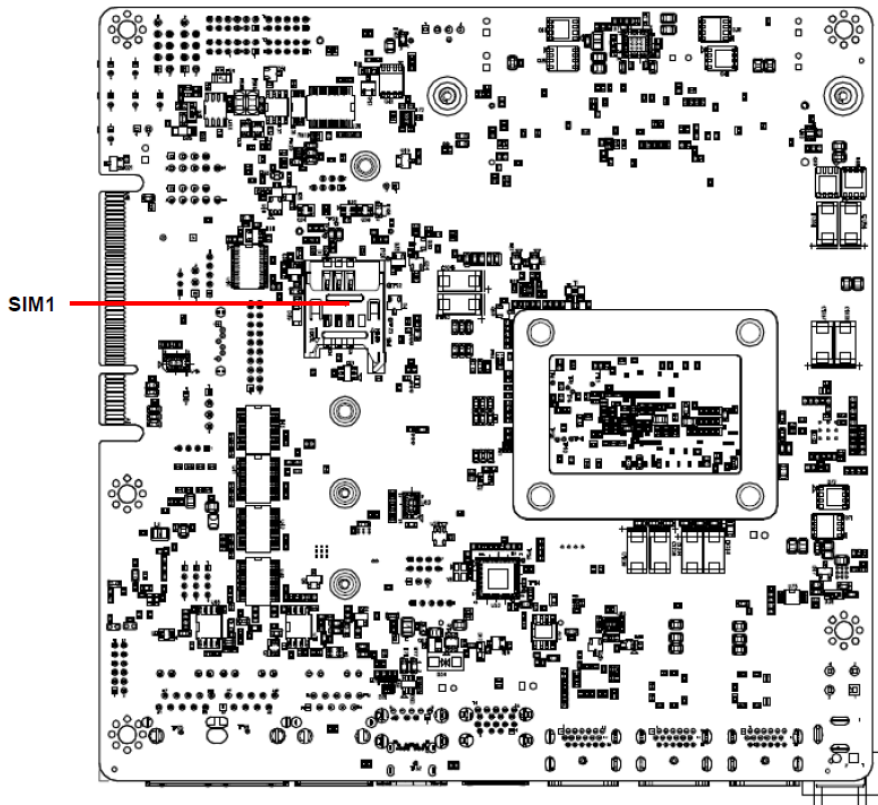
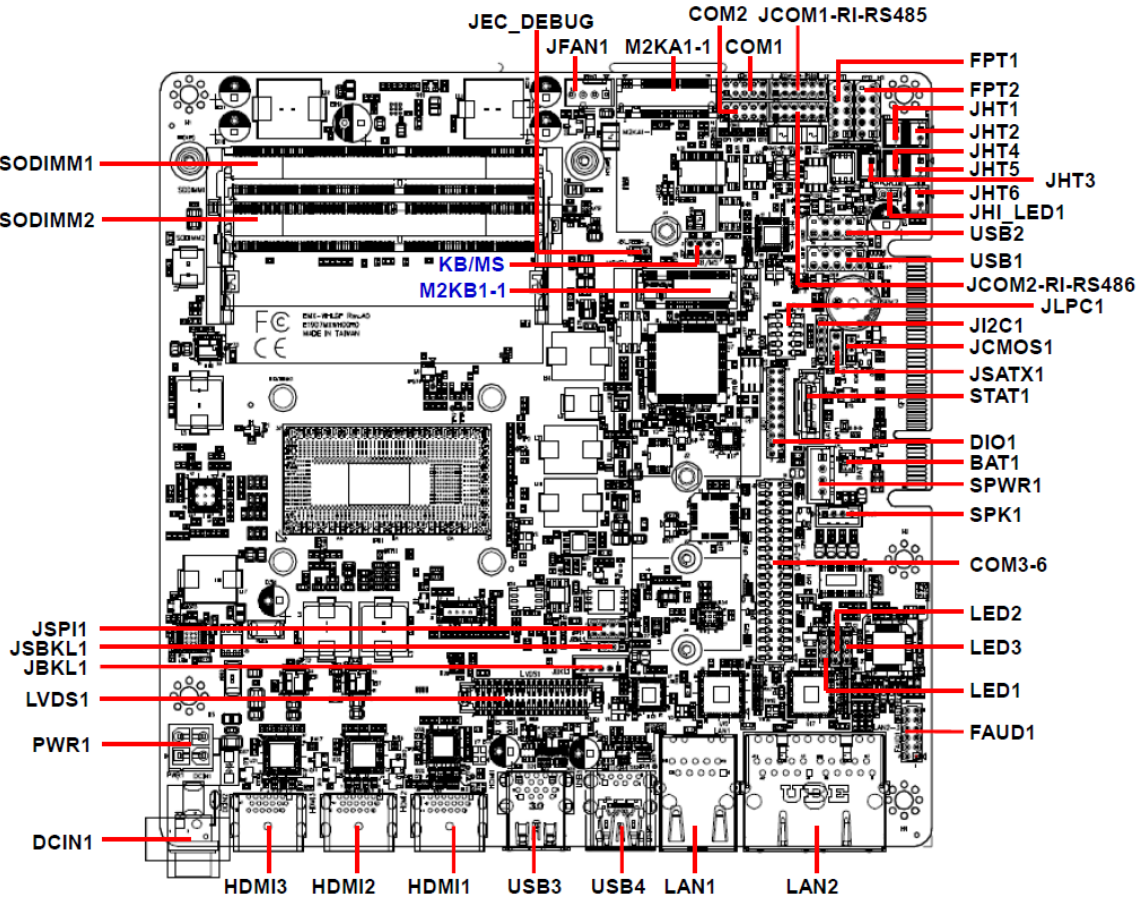

2.3 EMX-WHLGP Jumper & Connector list

The following tables list the function of each of the board's jumpers and connectors.

Jumpers

Label	Function	Note
JSBKL1	LVDS Back Light power selection	3 x 1 header, pitch 2.00mm
JSATX1	AT/ATX Power Mode Select	3 x 1 header, pitch 2.54mm
JCOMS1	Clear CMOS	3 x 1 header, pitch 2.00mm
JCOM1-RI-RS485	Serial port 1/2 pin9 signal select	6 x 2 header, pitch 2.00mm
JCOM2-RI-RS486	Serial port 1/2 pin9 signal select	6 x 2 header, pitch 2.00mm

Connectors

Label	Function	Note
FPT1/2	Miscellaneous setting connector 1/2	5 x 2 header, pitch 2.54mm
SODIMM1/2	206-pin DDR4 SO-DIMM socket	
FAUD1	Front Audio connector	6 x 2 header, pitch 2.00mm
JBKL1	LCD Inverter connector	5 x 1 wafer, pitch 2.00mm
JSPI1	SPI connector	4 x 2 header, pitch 2.00mm
JEC_DEBUG	EC Debug	2 x 1 header, pitch 2.00mm
COM1/2	Serial Port 1/2 connector	5 x 2 header, pitch 2.00mm
COM3-6	Serial Port 3-6 connector	20 x 2 header, pitch 2.00mm
DIO1	General purpose I/O connector	10 x 2 header, pitch 2.00mm
SPK1	Speaker connector	4 x 1 wafer, pitch 2.00mm
LVDS1	LVDS Connector	20 x 2 wafer, pitch 1.25mm
USB1/2	USB connector 1/2	5 x 2 header, pitch 2.54mm
USB3/4	USB connector 3/4	
LAN1/2	RJ-45 Ethernet 1/2	
LED1/2/3	LED indicator connector 1/2/3	4 x 1 header, pitch 2.00mm
M2KA1-1	M.2 2230 Key A slot	
M2KB1-1	M.2 3042/2242/2260/2280 Key B Slot	
JLPC	LPC connector	5 x 2 header, pitch 2.00mm
DCIN1	DC Power-in connector	
PWR1	Power connector	2 x 2 wafer, pitch 4.20mm
SATA1	Serial ATA connector	SATA1 is not functioning in EMX-SKLGP-3855 SKU

SLP-WHG-TSN

SPWR1	SATA Power connector	4 x 1 wafer, pitch 2.54mm
JI2C1	JI2C connector	5 x 1 header, pitch 2.00mm
HDMI1/2/3	HDMI connector 1/2/3	
JFAN1	CPU Fan connector	1 x 4 wafer, pitch 2.54 mm
SIM1	SIM card slot	
KB/MS	PS/2 keyboard & mouse header	4 x 2 header, pitch 2.00mm
BAT1	Battery connector	2 x 1 wafer, pitch 1.25mm
JHT_LED	LED Indicator for Heater	2 x 1 header, pitch 2.54mm
JHT1/23/4/5/6	CPU Heatsink Heater Connector	2 x 1 header, pitch 2.00mm
GF	Gold Finger	

2.4 EMX-WHLGP Setting Jumpers & Connectors

2.4.1 Serial port 1/2 pin9 signal select (JCOM1-RI-RS485)

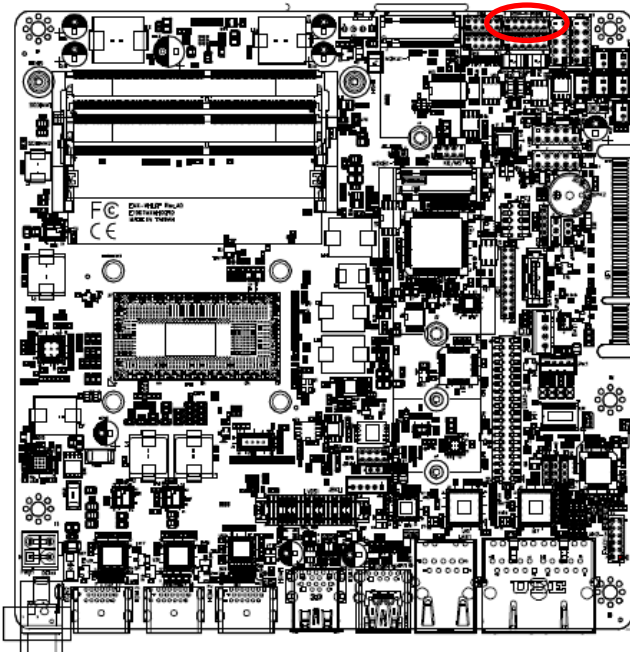

Ring*

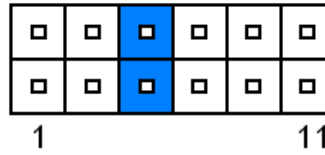

+12V

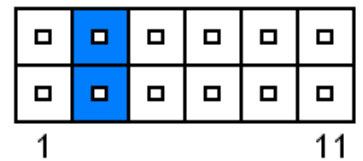

+5V

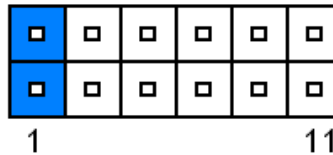

* Default

2.4.2 Serial port 1/2 pin9 signal select (JCOM2-RI-RS485)

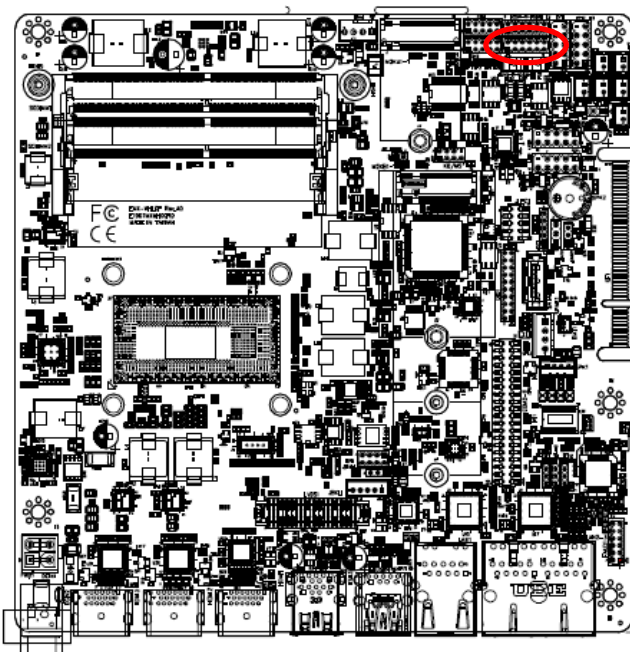

Ring*

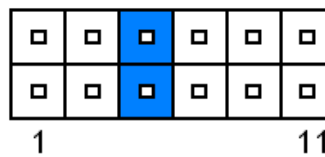

+12V

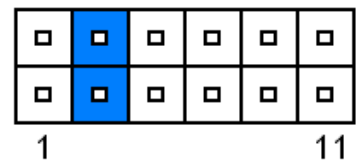

+5V

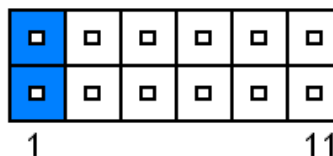

* Default

2.4.3 LVDS Back Light power selection (JSBKL1)

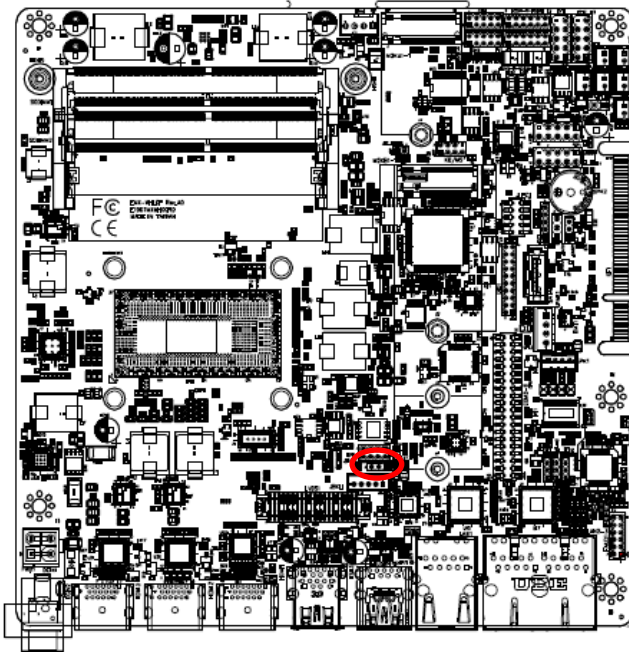

PWM Mode*

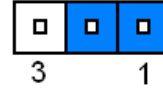

DC Mode

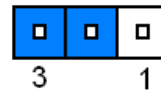

* Default

2.4.4 AT/ATX Power Mode Select (JSATX1)

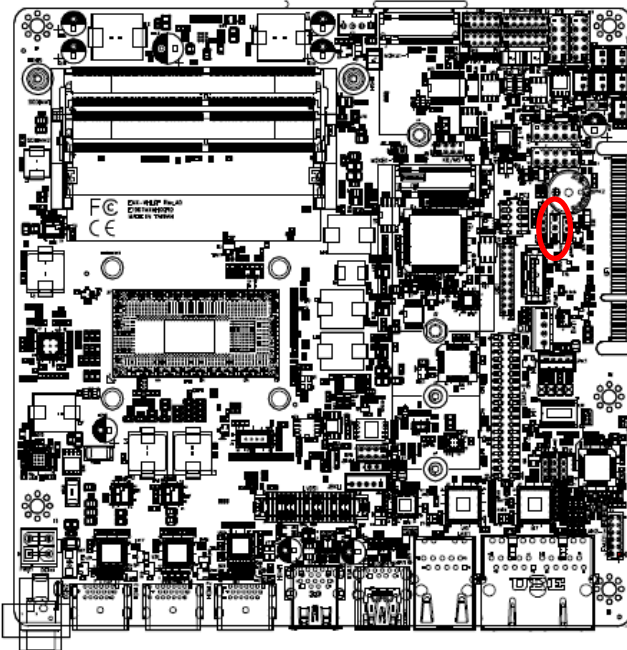

ATX*

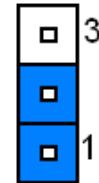

AT

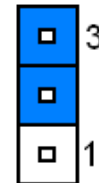

* Default

2.4.5 Clear CMOS (JCMOS1)

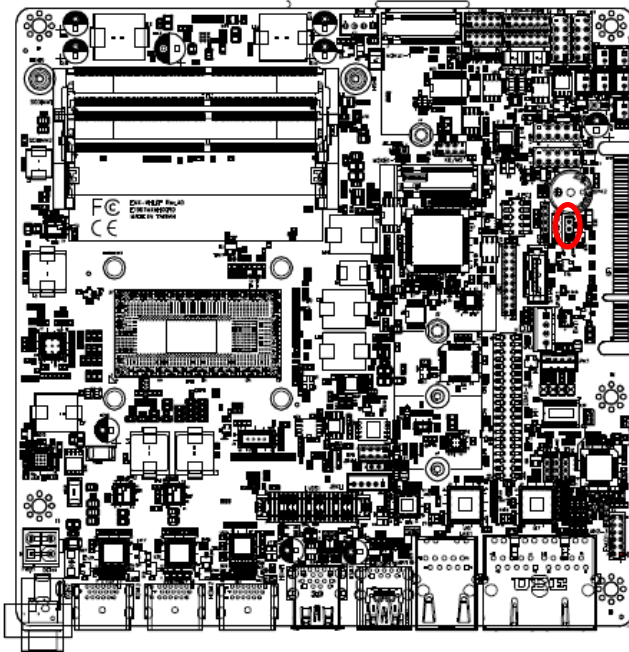

Protect*

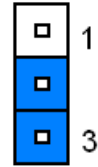

Clear CMOS

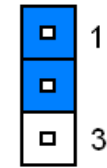

* Default

2.4.6 LCD Inverter connector (JBKL1)

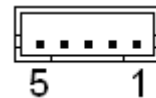
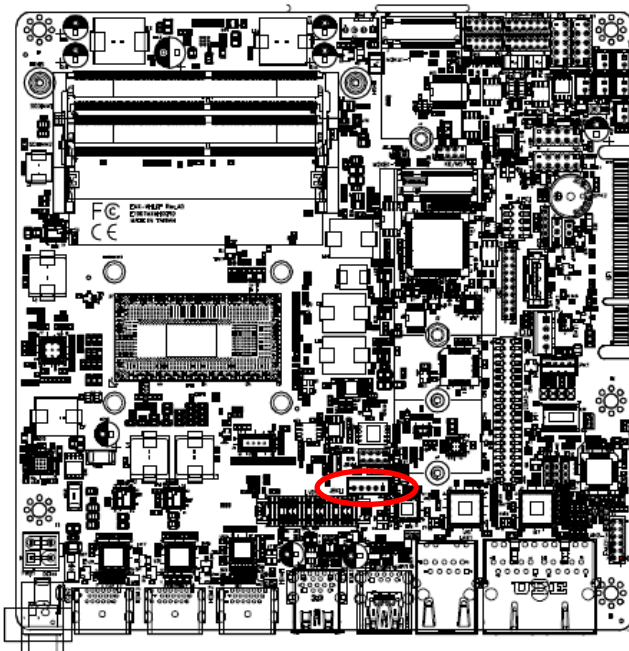

PIN	Signal
1	+12V
2	GND
3	LVDS_BKLT_EN
4	LVDS_BKLTCTL
5	+5V

2.4.7 Serial port 1 connector (COM1)

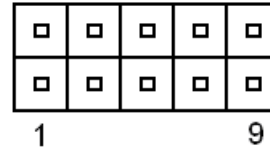
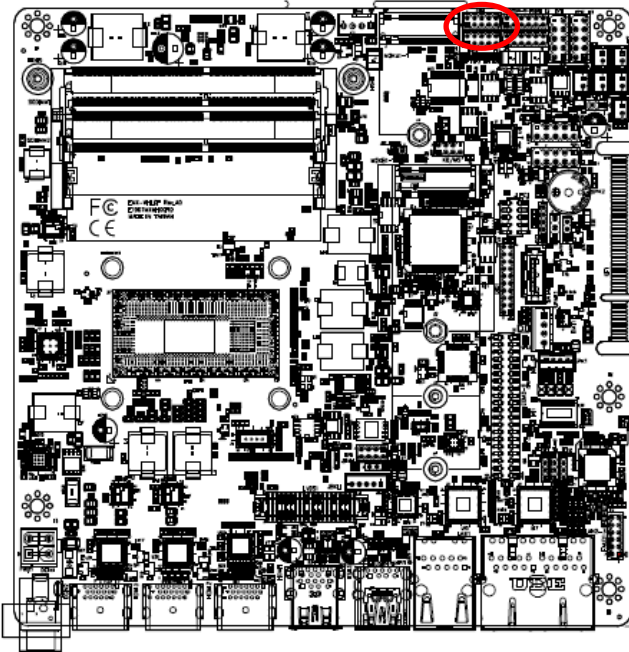

Signal	PIN	PIN	Signal
COM_DCD#_1	1	2	COM_RXD_1
COM_TXD_1	3	4	COM_DTR#_1
GND	5	6	COM_DSR#_1
COM_RTS#_1	7	8	COM_CTS#_1
COM_R#_1_R	9	10	NC

2.4.8 Serial port 2 connector (COM2)

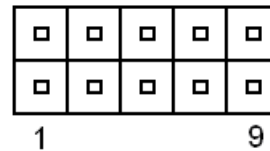
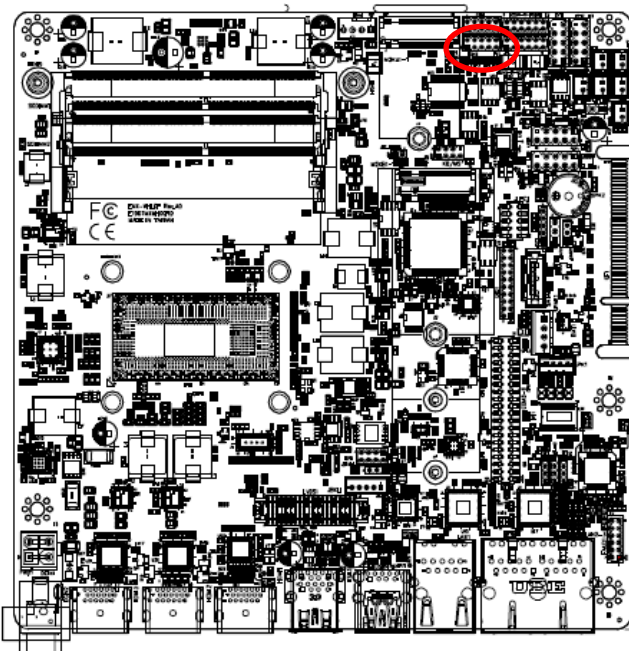

Signal	PIN	PIN	Signal
COM_DCD#_2	1	2	COM_RXD_2
COM_TXD_2	3	4	COM_DTR#_2
GND	5	6	COM_DSR#_2
COM_RTS#_2	7	8	COM_CTS#_2
COM_R#_2_R	9	10	NC

2.4.9 General purpose I/O connector (DIO1)

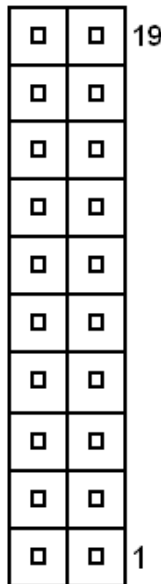
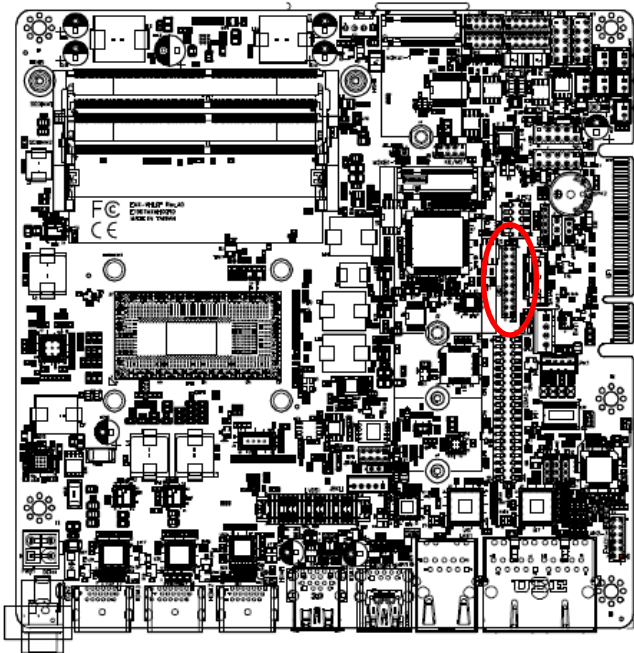

Signal	PIN	PIN	Signal
DI0	1	2	DO0
DI1	3	4	DO1
DI2	5	6	DO2
DI3	7	8	DO3
DI4	9	10	DO4
DI5	11	12	DO5
DI6	13	14	DO6
DI7	15	16	DO7
SMB_CLK_S	17	18	SMB_DATA_S
GND	19	20	+5V

2.4.10 SPI connector (JSPI1)

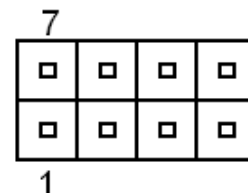
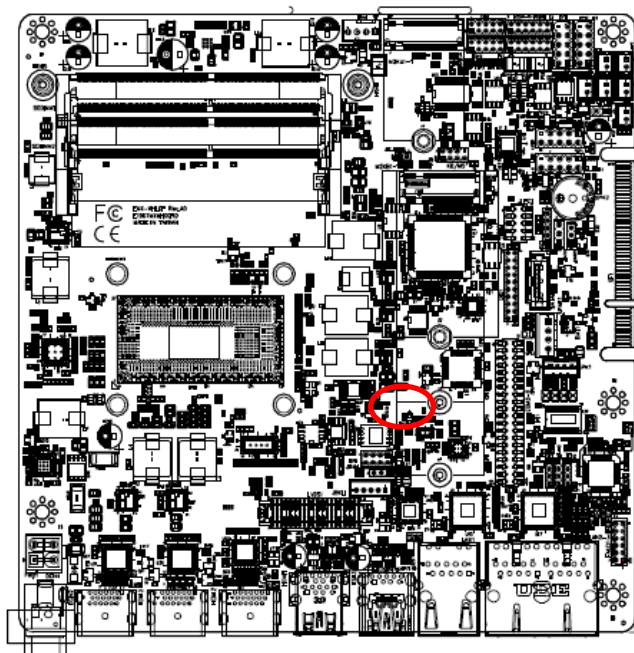

Signal	PIN	PIN	Signal
+3.3A_SPI	1	2	GND
SPI0_CS0#	3	4	SPI_CLK
SPI_SO	5	6	SPI_SI
HOLD#	7	8	SPI_WP#

2.4.11 Serial port 3-6 connector (COM3-6)

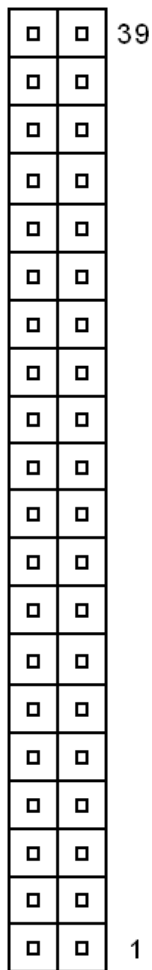
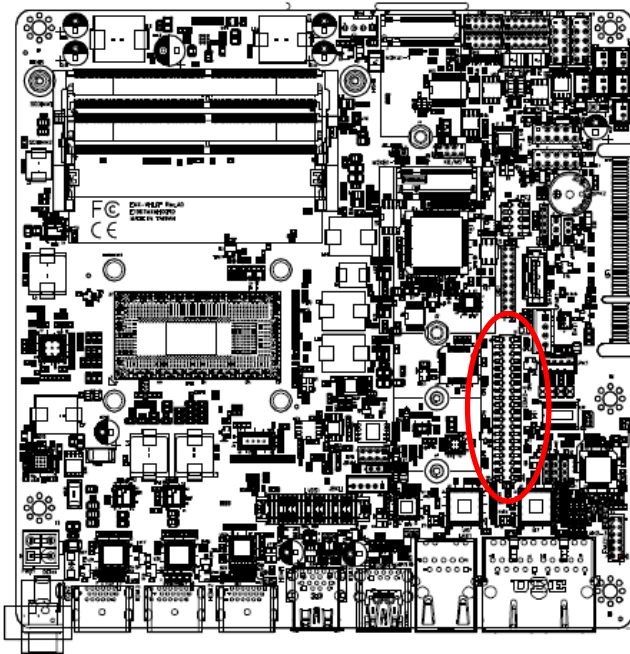

Signal	PIN	PIN	Signal
NC	40	39	COM_R#_6
COM_CTS#_6	38	37	COM_RTS#_6
COM_DSR#_6	36	35	GND
COM_DTR#_6	34	33	COM_TXD_6
COM_RXD_6	32	31	COM_DCD#_6
NC	30	29	COM_R#_5
COM_CTS#_5	28	27	COM_RTS#_5
COM_DSR#_5	26	25	GND
COM_DTR#_5	24	23	COM_TXD_5
COM_RXD_5	22	21	COM_DCD#_5
NC	20	19	COM_R#_4
COM_CTS#_4	18	17	COM_RTS#_4
COM_DSR#_4	16	15	GND
COM_DTR#_4	14	13	COM_TXD_4
COM_RXD_4	12	11	COM_DCD#_4
NC	10	9	COM_R#_3
COM_CTS#_3	8	7	COM_RTS#_3
COM_DSR#_3	6	5	GND
COM_DTR#_3	4	3	COM_TXD_3
COM_RXD_3	2	1	COM_DCD#_3

2.4.12 SATA Power connector (SPWR1)

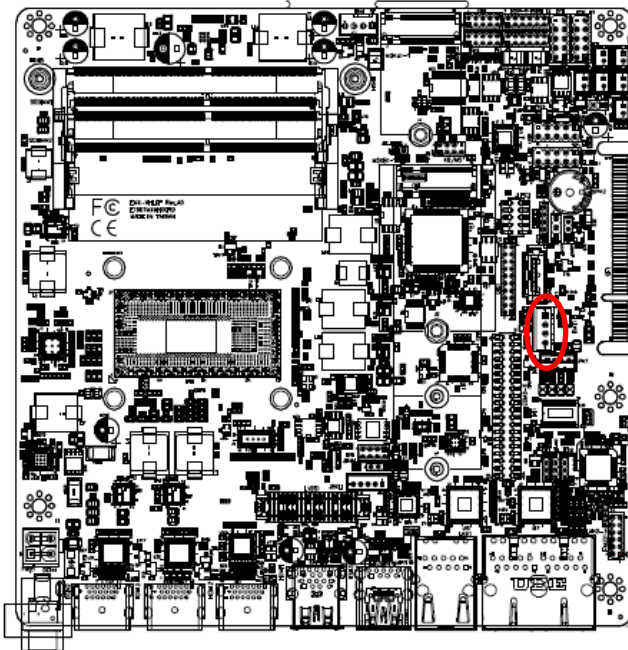

PIN	Signal
1	+V5S_SATA1
2	GND
3	GND
4	+V12S_SATA1

2.4.13 CPU Fan connector (JFAN1)

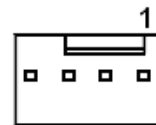
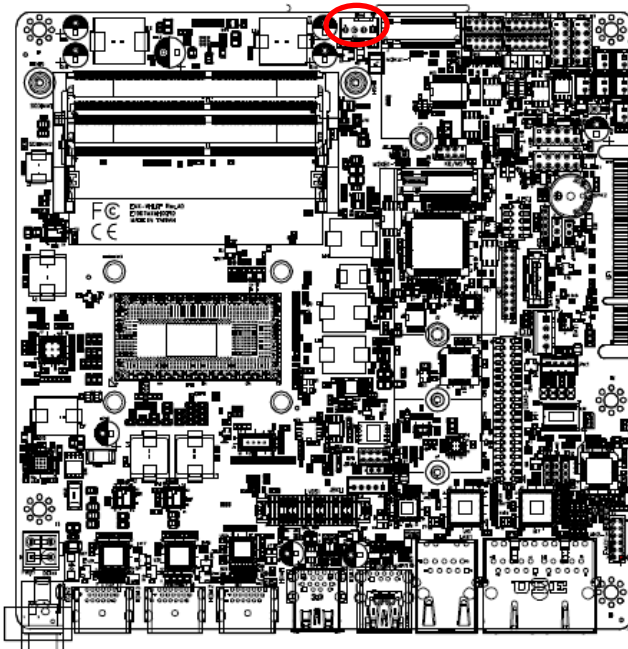

PIN	Signal
1	GND
2	+12V_FAN1
3	CPUFANIN
4	FAN_PWM0

2.4.14 USB connector 1(USB1)

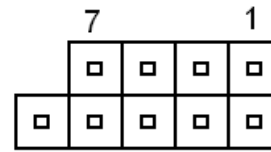
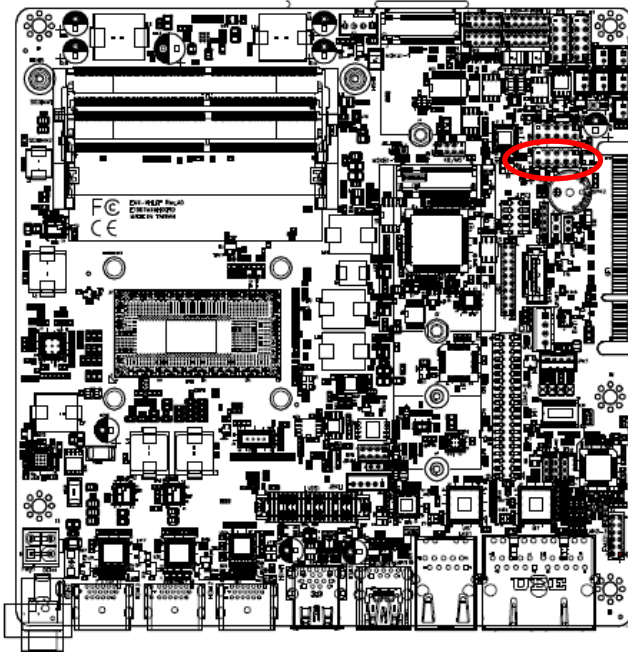

Signal	PIN	PIN	Signal
+V5A_HUB1-4	1	2	+V5A_HUB1-4
UHUB_DM1_R	3	4	UHUB_DM2_R
UHUB_DP1_R	5	6	UHUB_DP2_R
GND	7	8	GND
		10	NC

2.4.15 USB connector 2(USB2)

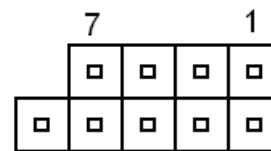
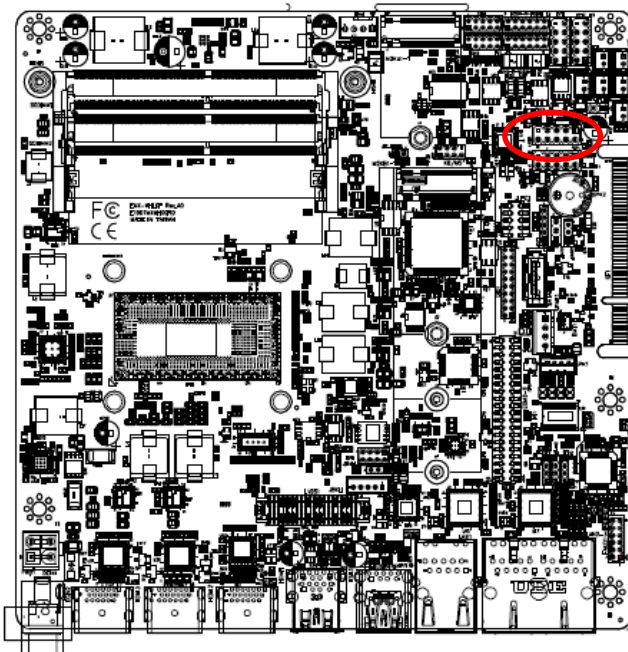

Signal	PIN	PIN	Signal
+V5A_HUB1-4	1	2	+V5A_HUB1-4
UHUB_DM3_R	3	4	UHUB_DM4_R
UHUB_DP3_R	5	6	UHUB_DP4_R
GND	7	8	GND
		10	NC

2.4.16 LVDS connector (LVDS1)

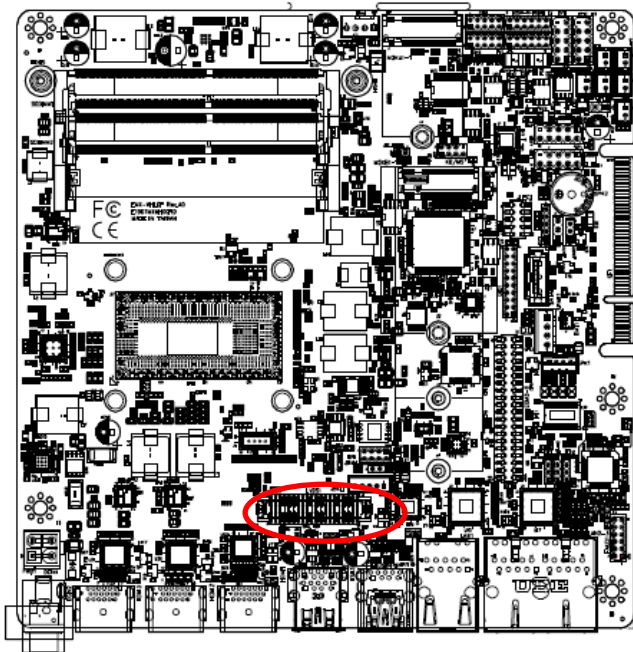

Signal	PIN	PIN	Signal
+5V_LVDS	2	1	+3.3V_LVDS
+5V_LVDS	4	3	+3.3V_LVDS
NC	6	5	NC
GND	8	7	GND
LVDS_DATA0_P	10	9	LVDS_DATA1_P
LVDS_DATA0_N	12	11	LVDS_DATA1_N
GND	14	13	GND
LVDS_DATA2_P	16	15	LVDS_DATA3_P
LVDS_DATA2_N	18	17	LVDS_DATA3_N
GND	20	19	GND
LVDS_DATA4_P	22	21	LVDS_DATA5_P
LVDS_DATA4_N	24	23	LVDS_DATA5_N
GND	26	25	GND
LVDS_DATA6_P	28	27	LVDS_DATA7_P
LVDS_DATA6_N	30	29	LVDS_DATA7_N
GND	32	31	GND
LVDS_CLK1_P	34	33	LVDS_CLK2_P
LVDS_CLK1_N	36	35	LVDS_CLK2_N
GND	38	37	GND
+12V	40	39	+12V

2.4.17 Front Audio connector (FAUD1)

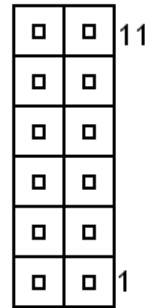
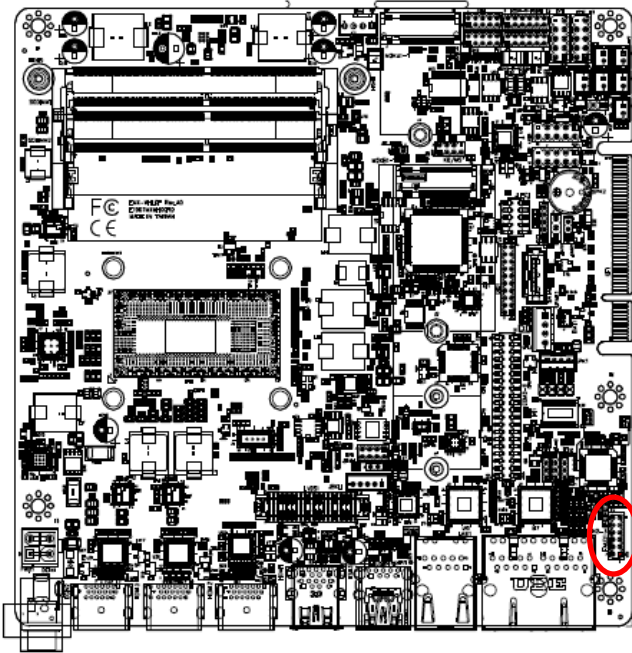

Signal	PIN	PIN	Signal
GND_AUD	12	11	MIC1_JD
NC	10	9	LINEOUT1_JD
MIC1_LIN	8	7	MIC1_RIN
NC	6	5	NC
GND_AUD	4	3	GND_AUD
LINEOUT_L	2	1	LINEOUT_R

2.4.18 EC Debug (JEC_DEBUG)

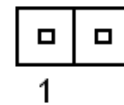
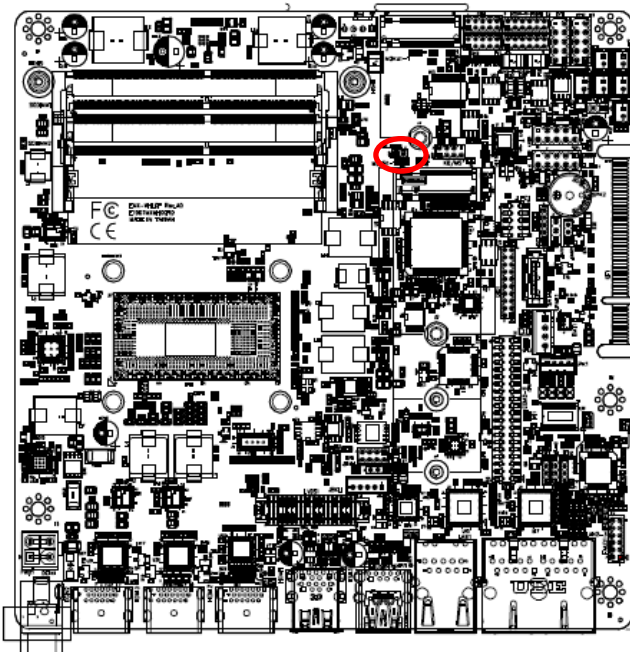

PIN	Signal
1	EC_SMCLK
2	EC_SMDAT

2.4.19 Battery connector (BAT1)

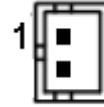
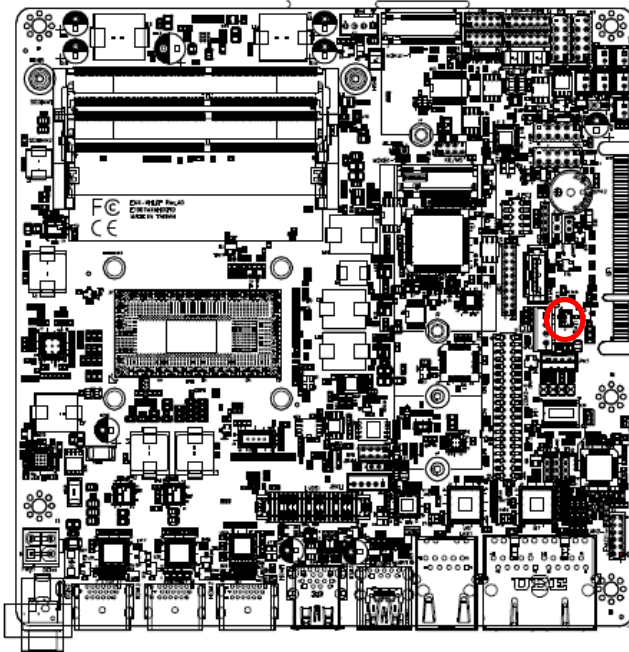

PIN	Signal
1	+VRTCBAT
2	GND

2.4.20 PS/2 keyboard & mouse header (KB/MS)

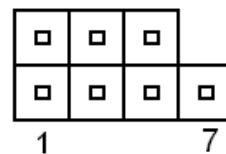
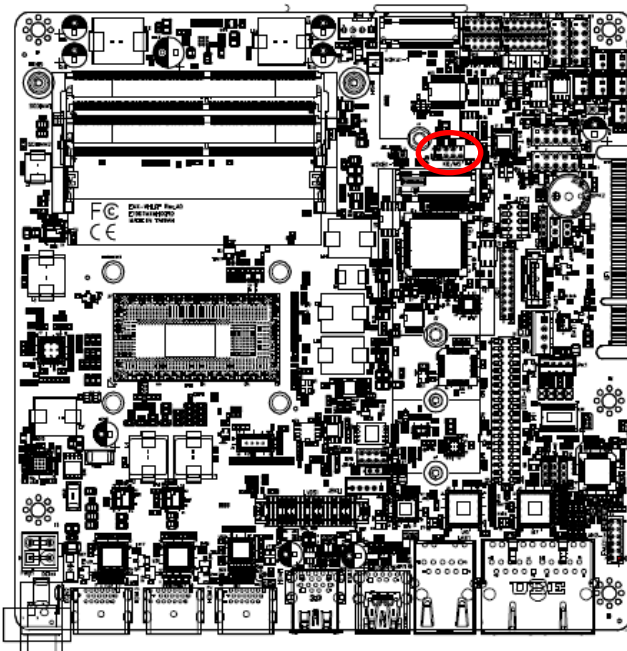

Signal	PIN	PIN	Signal
KBDAT	1	2	KBCLK
GND	3	4	5V
MSDAT	5	6	MSCLK
NC	7		

2.4.21 Miscellaneous setting connector 1 (FPT1)

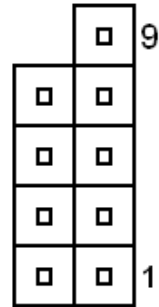
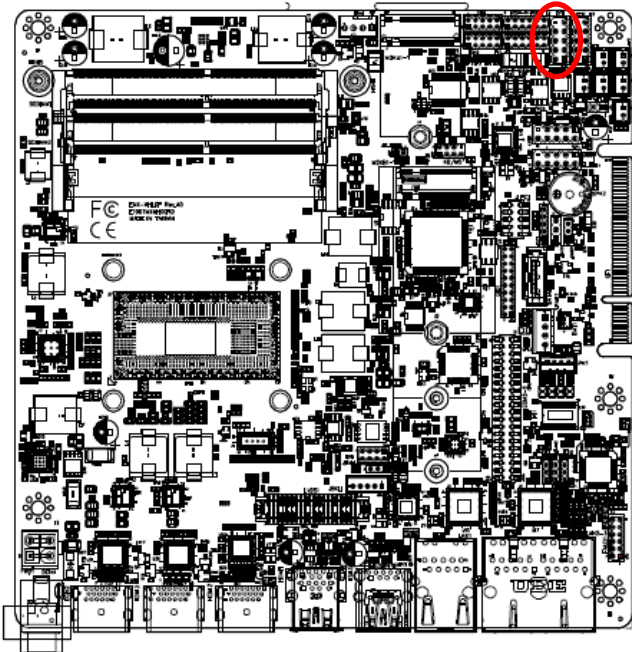

Signal	PIN	PIN	Signal
		9	NC
-PWR_BTN	8	7	-Reset
+PWR_BTN	6	5	+Reset
-PWR_LED	4	3	-HD_LED
+PWR_LED	2	1	+HD_LED

2.4.22 Miscellaneous setting connector 2 (FPT2)

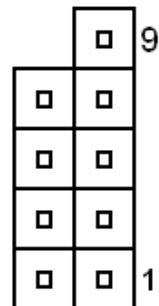
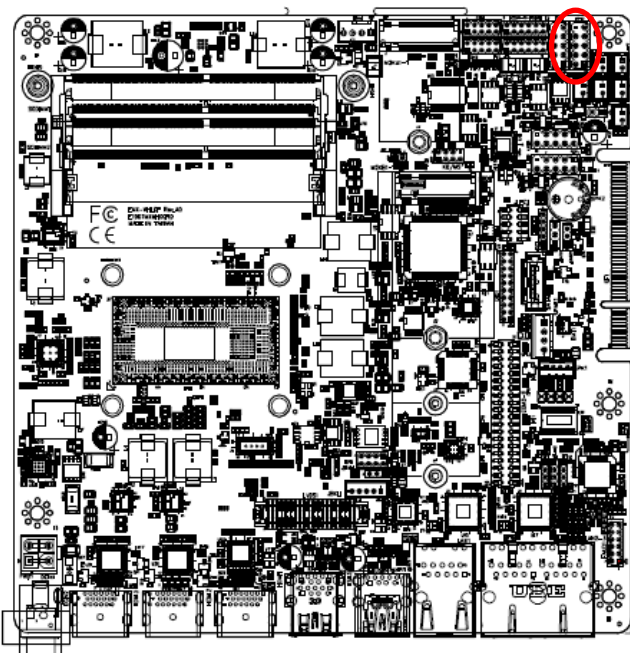

Signal	PIN	PIN	Signal
Speaker+	1	2	BLK_VR(10K)
NC	3	4	BLK_UP
NC	5	6	BLK_DN
Speaker-	7	8	GND
NC	9	10	

2.4.23 LED indicator connector 1 (LED1)

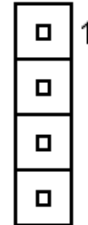
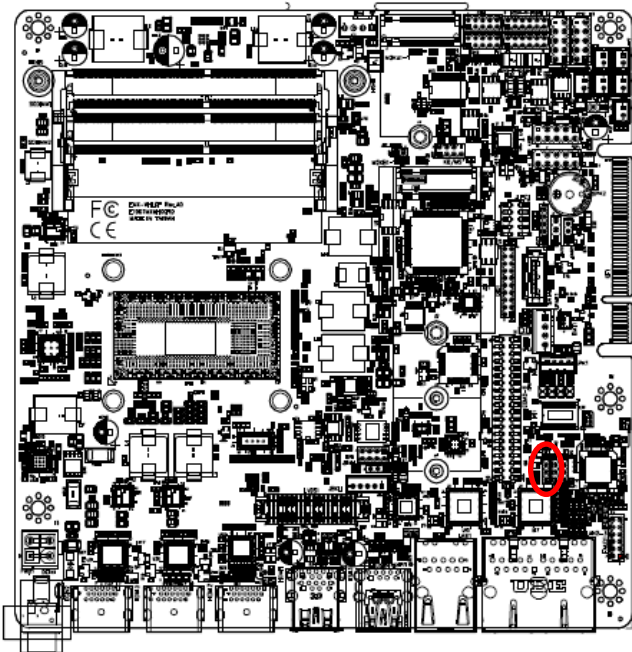

PIN	Signal
1	LAN1_ACT_P
2	LAN1_ACT_N
3	LAN1_100#_LED
4	LAN1_1000#_LED

2.4.24 LED indicator connector 2 (LED2)

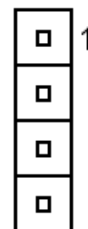
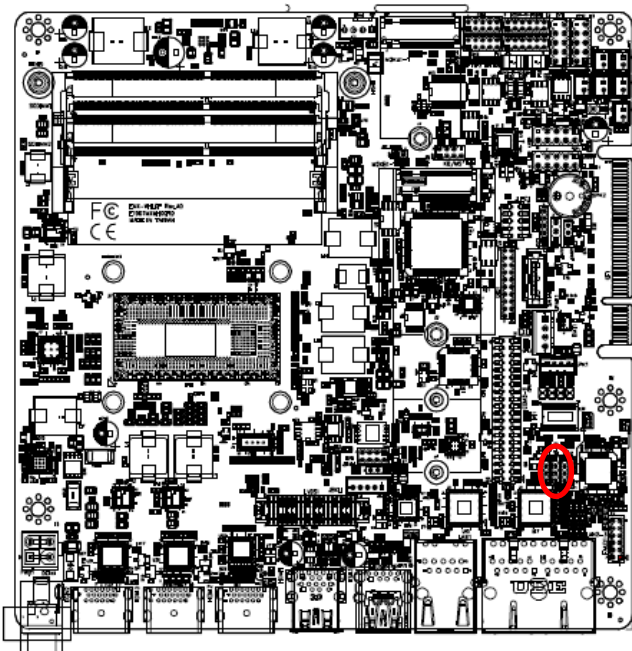

PIN	Signal
1	LAN2_ACT_P
2	LAN2_ACT_N
3	LAN2_100#_LED
4	LAN2_1000#_LED

2.4.25 LED indicator connector 3 (LED3)

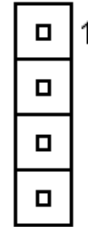
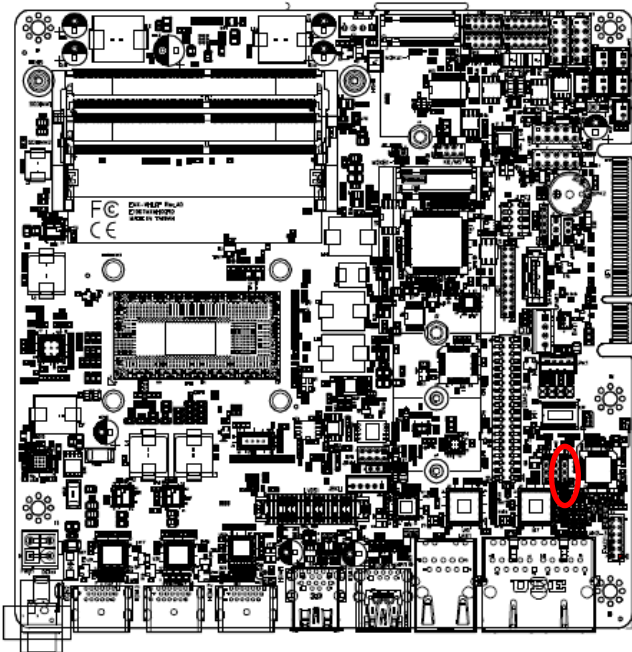

PIN	Signal
1	LAN3_ACT_P
2	LAN3_ACT_N
3	LAN3_100#_LED
4	LAN3_1000#_LED

2.4.26 Speaker connector (SPK1)

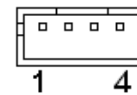
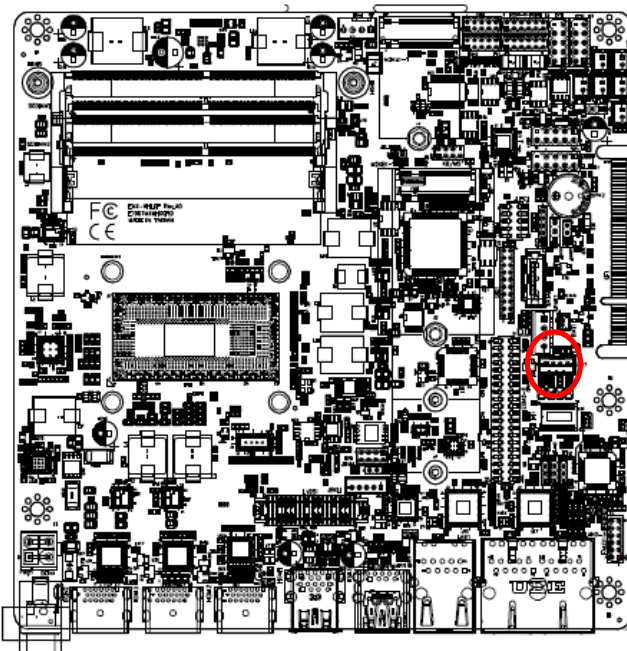

PIN	Signal
1	SPK_L+
2	SPK_L-
3	SPK_R+
4	SPK_R-

2.4.27 JI2C connector (JI2C1)

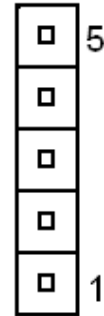
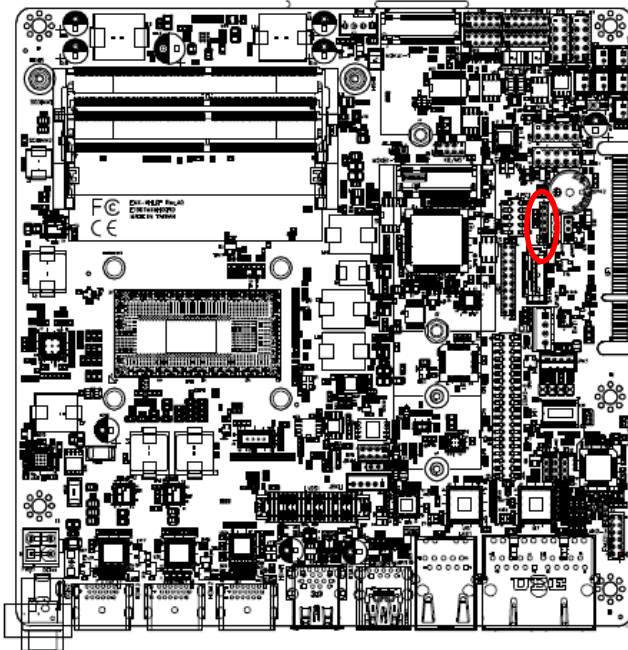

PIN	Signal
1	+3.3V
2	INT_I2C0#
3	I2C0_CLK
4	I2C0_DATA
5	GND

2.4.28 LPC connector (JLPC1)

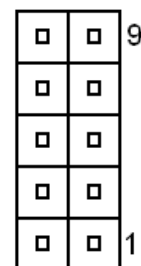
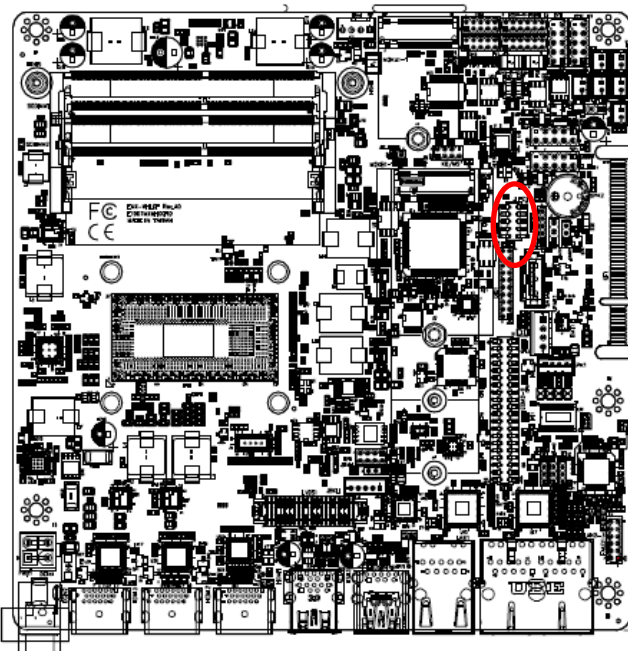

Signal	PIN	PIN	Signal
GND	10	9	LPC_SERIRQ
LPC_CLK	8	7	LPC_AD3
LPC_FRAME#	6	5	LPC_AD2
PCH_PLTRST#	4	3	LPC_AD1
+3.3V	2	1	LPC_AD0

2.4.29 CPU Heatsink Heater Connector (JHT1/2/3/4/5/6)

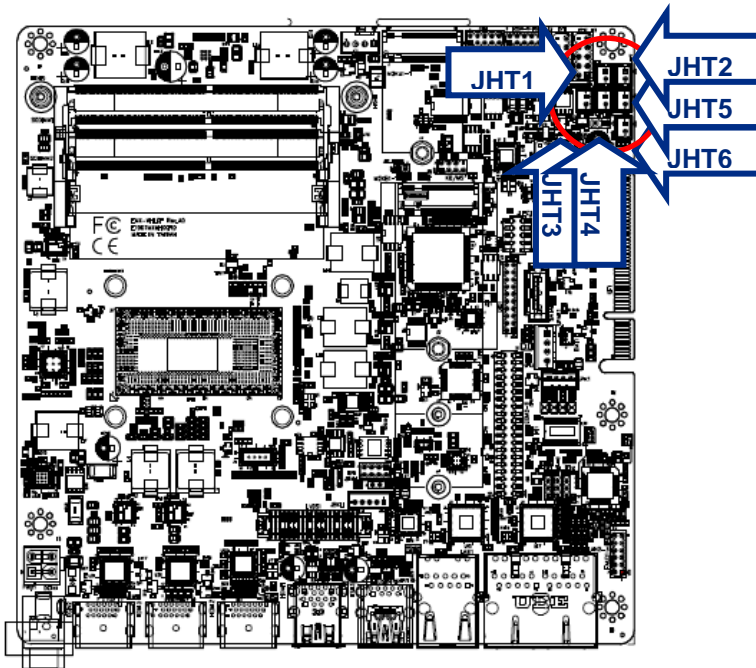

PIN	Signal
1	+12V
2	GND

2.4.30 LED Indicator for Heater (JHT_LED1)

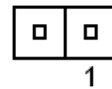
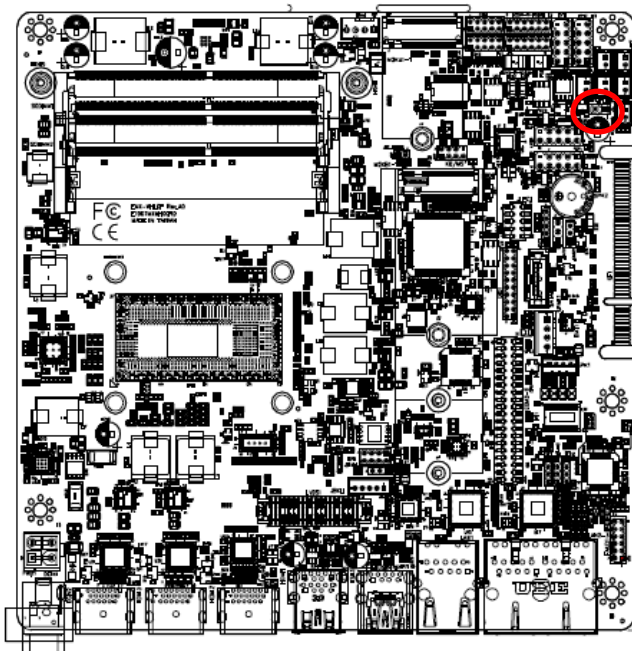

PIN	Signal
1	+12V
2	GND

2.4.31 Gold Finger (GF)

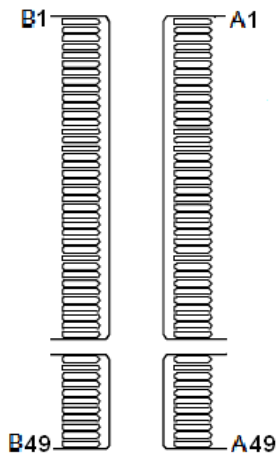
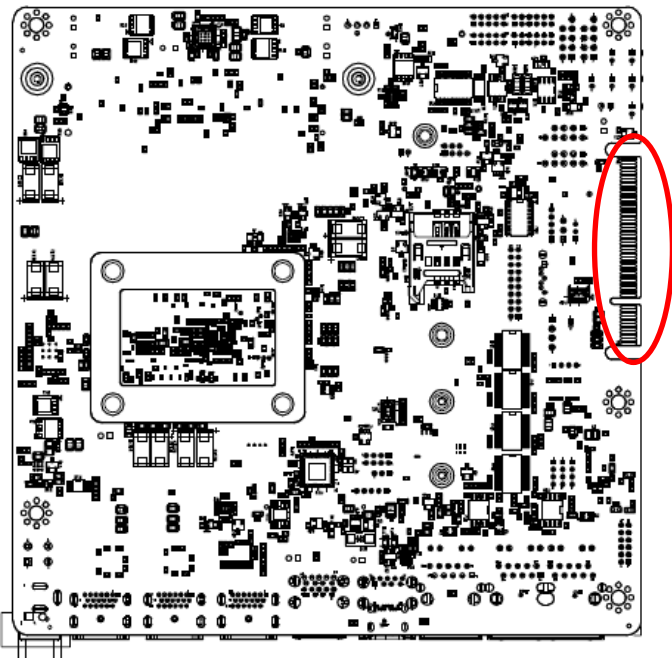
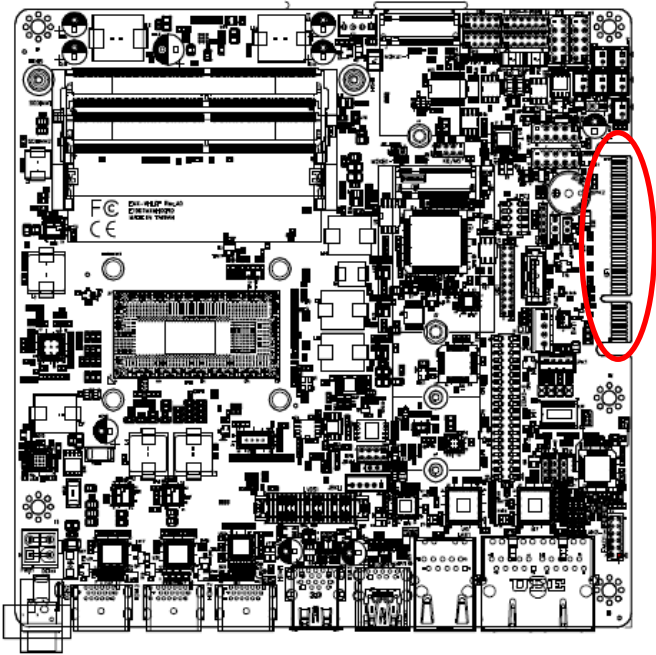

Signal	PIN	PIN	Signal
+12V	B1	A1	+12V
+12V	B2	A2	+12V
+12V	B3	A3	+12V
GND	B4	A4	GND
SMB_CLK_S	B5	A5	EN_V5S-V3.3S
SMB_DATA_S	B6	A6	GF_PWR_OK
GND	B7	A7	GF_CKL_REQ#
NC	B8	A8	GF_SATA1_DEVSLP
GF_PWR_BTN_EC#	B9	A9	+5V
+3.3V	B10	A10	+5V
GF_PWAKE#	B11	A11	RST_GF#
	KEY		
USB_PWR_EN_GF	B12	A12	GND
GND	B13	A13	CLK_GF_P5
PCIE_TXP13	B14	A14	CLK_GF_N5
PCIE_TXN13	B15	A15	GND
GND	B16	A16	PCIE_RXP13
NC	B17	A17	PCIE_RXN13
GND	B18	A18	GND
PCIE_TXP14	B19	A19	NC
PCIE_TXN14	B20	A20	GND
GND	B21	A21	PCIE_RXP14
GND	B22	A22	PCIE_RXN14
PCIE_TXP15	B23	A23	GND
PCIE_TXN15	B24	A24	GND
GND	B25	A25	PCIE_RXP15

SLP-WHG-TSN

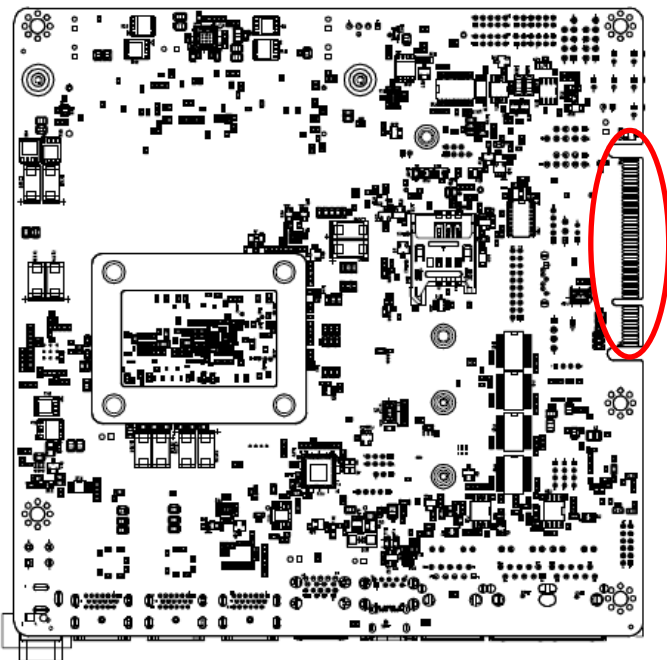
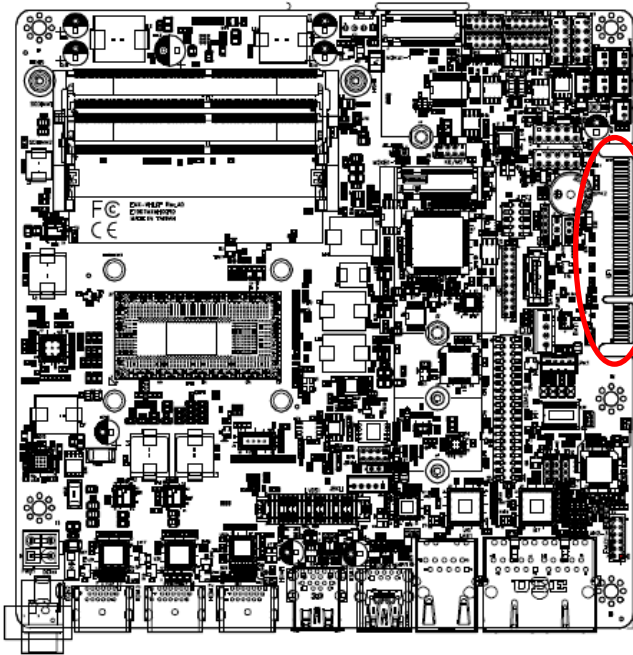

Signal	PIN	PIN	Signal
GND	B26	A26	PCIE_RXN15
PCIE_TXP16	B27	A27	GND
PCIE_TXN16	B28	A28	GND
GND	B29	A29	PCIE_RXP16
NC	B30	A30	PCIE_RXN16
NC	B31	A31	GND
GND	B32	A32	NC
USB_PP7	B33	A33	GF_USB_OC#
USB_PN7	B34	A34	GND
GND	B35	A35	NC
GND	B36	A36	NC
SATA_TXP_1_GF_L	B37	A37	GND
SATA_TXN_1_GF_L	B38	A38	GND
GND	B39	A39	SATA_RXN_1_GF_L
GND	B40	A40	SATA_RXP_1_GF_L
PCIE_GF_TXP9	B41	A41	GND
PCIE_GF_TXN9	B42	A42	GND
GND	B43	A43	PCIE_GF_RXP9
GND	B44	A44	PCIE_GF_RXN9
NC	B45	A45	GND
NC	B46	A46	GND
GND	B47	A47	NC
NC	B48	A48	NC
GND	B49	A49	GND

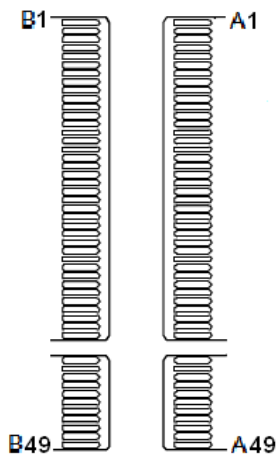

2.4.32 Power connector (PWR1)

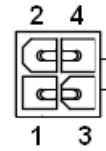
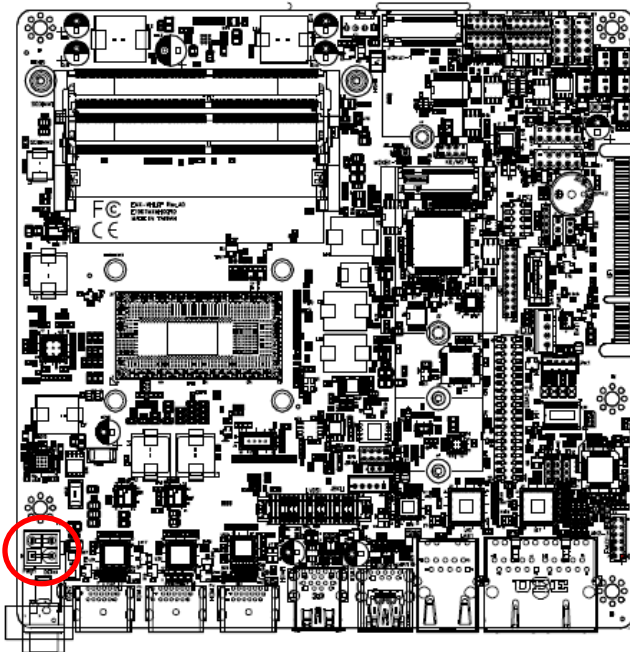

Signal	PIN	PIN	Signal
GND	2	4	+VIN
GND	1	3	+VIN

Note: VIN = 12~24V

3. BIOS Setup



3.1 Introduction

The BIOS setup program allows users to modify the basic system configuration. In this following chapter will describe how to access the BIOS setup program and the configuration options that may be changed.

3.2 Starting Setup

The AMI BIOS™ is immediately activated when you first power on the computer. The BIOS reads the system information contained in the NVRAM and begins the process of checking out the system and configuring it. When it finishes, the BIOS will seek an operating system on one of the disks and then launch and turn control over to the operating system.

While the BIOS is in control, the Setup program can be activated in one of two ways:

By pressing or <F2> immediately after switching the system on, or

By pressing the or <F2> key when the following message appears briefly at the left-top of the screen during the POST (Power On Self Test).

Press or <F2> to enter SETUP

If the message disappears before you respond and you still wish to enter Setup, restart the system to try again by turning it OFF then ON or pressing the "RESET" button on the system case. You may also restart by simultaneously pressing <Ctrl>, <Alt>, and <Delete> keys. If you do not press the keys at the correct time and the system does not boot, an error message will be displayed and you will again be asked to.

Press F1 to Continue, DEL to enter SETUP

3.3 Using Setup

In general, you use the arrow keys to highlight items, press <Enter> to select, use the PageUp and PageDown keys to change entries, press <F1> for help and press <Esc> to quit. The following table provides more detail about how to navigate in the Setup program using the keyboard.

Button	Description
↑↓→←	Move
Enter	Select
+/-	Value
Esc	Exit
F1	General Help
F2	Previous Values
F3	Optimized Defaults
F4	Save & Exit Setup
<K>	Scroll help area upwards
<M>	Scroll help area downwards

- **Navigating Through The Menu Bar**

Use the left and right arrow keys to choose the menu you want to be in.



Note: Some of the navigation keys differ from one screen to another.

- **To Display a Sub Menu**

Use the arrow keys to move the cursor to the sub menu you want. Then press <Enter>. A “>” pointer marks all sub menus.

3.4 Getting Help

Press F1 to pop up a small help window that describes the appropriate keys to use and the possible selections for the highlighted item. To exit the Help Window press <Esc> or <Enter> key.

3.5 In Case of Problems

If, after making and saving system changes with Setup, you discover that your computer no longer is able to boot, the AMI BIOS supports an override to the NVRAM settings which resets your system to its defaults.

The best advice is to only alter settings which you thoroughly understand. To this end, we strongly recommend that you avoid making any changes to the chipset defaults. These defaults have been carefully chosen by both BIOS Vendor and your systems manufacturer to provide the absolute maximum performance and reliability. Even a seemingly small change to the chipset setup has the potential for causing you to use the override.

3.6 BIOS setup

Once you enter the Aptio Setup Utility, the Main Menu will appear on the screen. The Main Menu allows you to select from several setup functions and exit choices. Use the arrow keys to select among the items and press <Enter> to accept and enter the sub-menu.

3.6.1 Main Menu

This section allows you to record some basic hardware configurations in your computer and set the system clock.

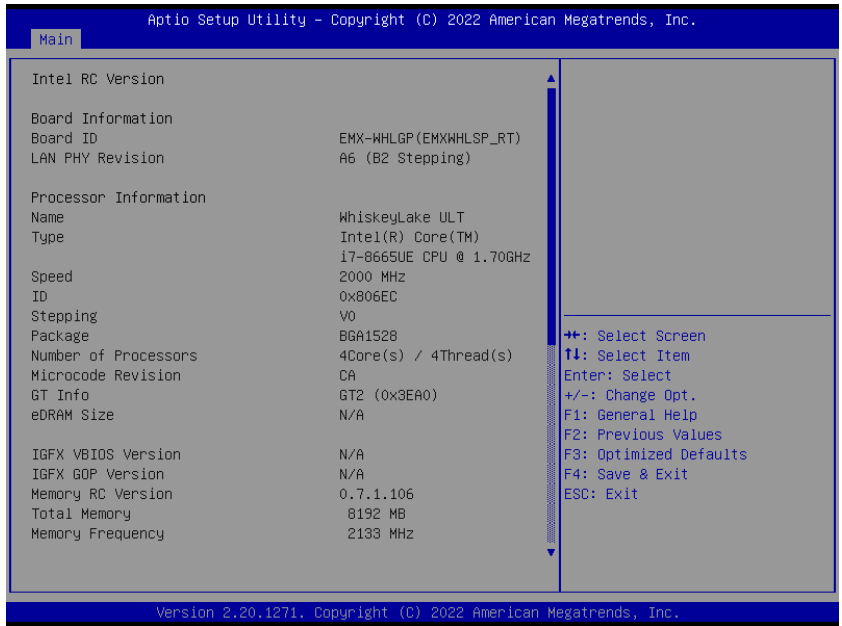
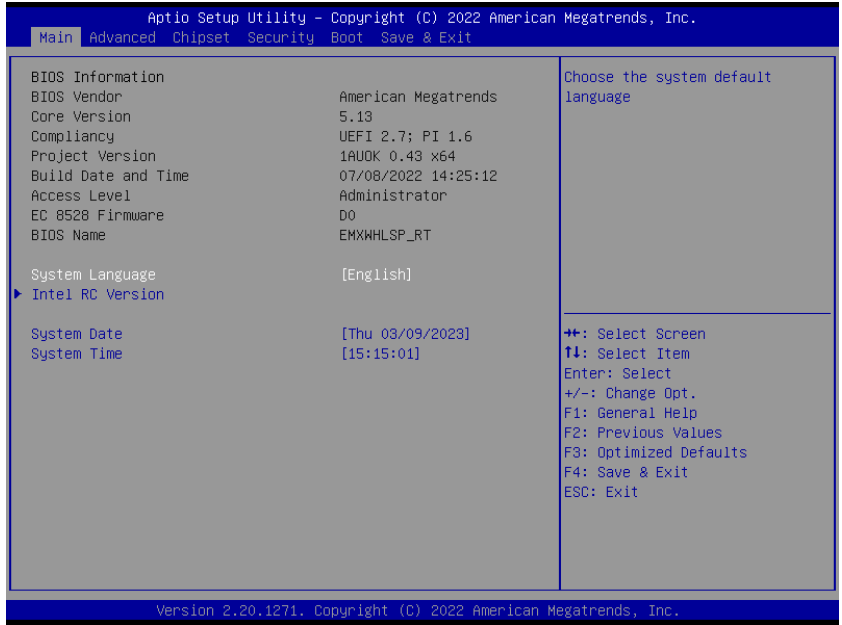

3.6.1.1 System Language

This option allows choosing the system default language.

3.6.1.2 System Date

Use the system date option to set the system date. Manually enter the month/day/year.

3.6.1.3 System Time

Use the system time option to set the system time. Manually enter the hours, minutes and seconds.



Note: The BIOS setup screens shown in this chapter are for reference purposes only, and may not exactly match what you see on your screen. Visit the Avalue website (www.avalu.com.tw) to download the latest product and BIOS information.

3.6.2 Advanced Menu

This section allows you to configure your CPU and other system devices for basic operation through the following sub-menus.

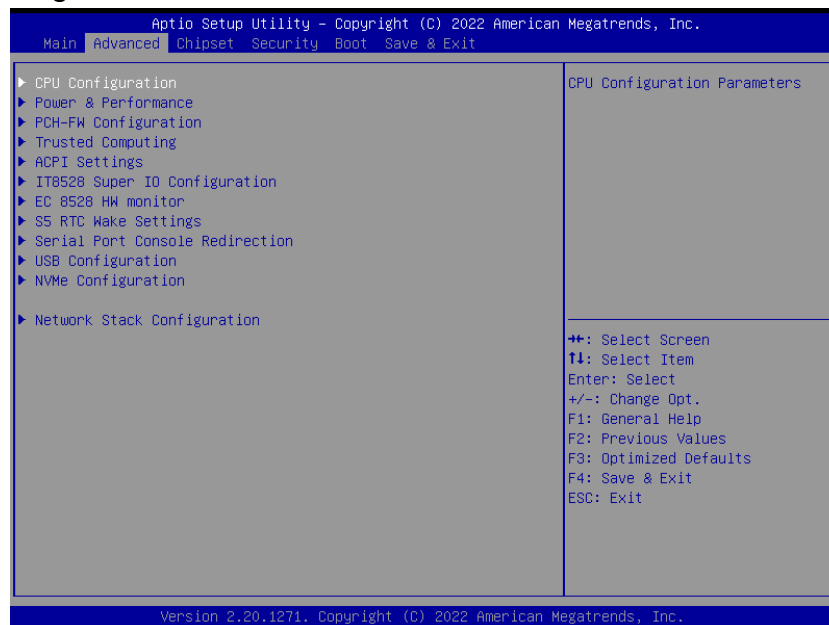

3.6.2.1 CPU Configuration

Use the CPU configuration menu to view detailed CPU specification and configure the CPU.



Item	Options	Description
Intel (VMX) Virtualization Technology	Disabled, Enabled[Default]	When enabled, a VMM can utilize the additional hardware capabilities provided by Vanderpool Technology.
Active Processor Cores	All[Default] 1/2/3/4	Number of cores to enable in each processor package.

3.6.2.2 Power & Performance

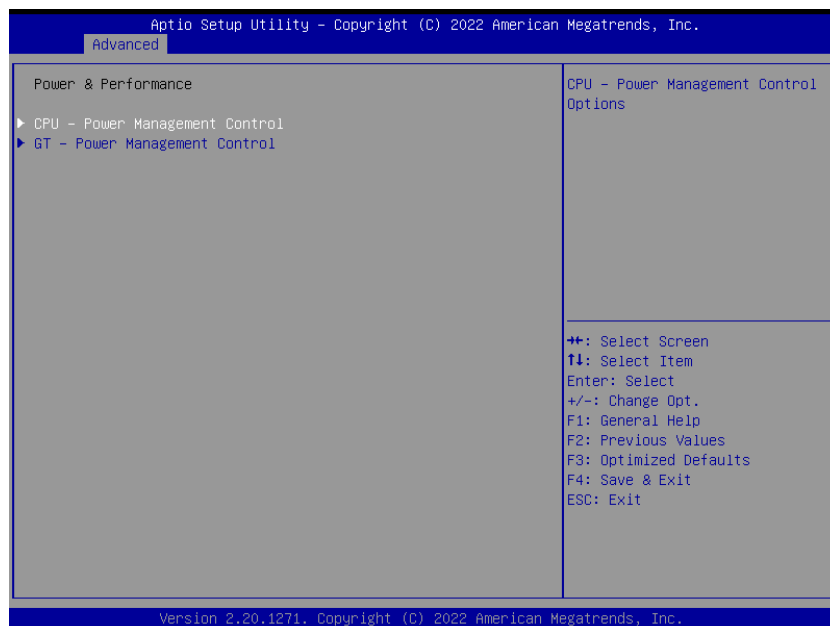

3.6.2.2.1 CPU - Power Management Control

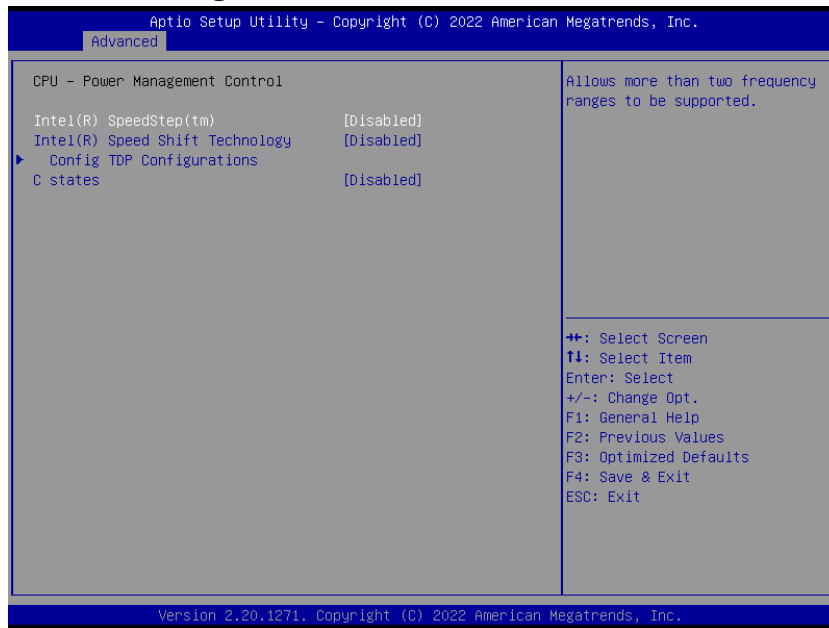

Item	Options	Description
Intel(R) SpeedStep(tm)	Disabled[Default], Enabled	Allows more than two frequency ranges to be supported.
Intel(R) Speed Shift Technology	Disabled[Default], Enabled	Enable/Disable Intel(R) Speed Shift Technology support. Enabling will expose the CPPC v2 interface to allow for hardware controlled P-states.
C states	Disabled[Default], Enabled	Enable/Disable CPU Power Management. Allows CPU to go to C states when it's not 100% utilized.

3.6.2.2.1.1 Config TDP Configurations

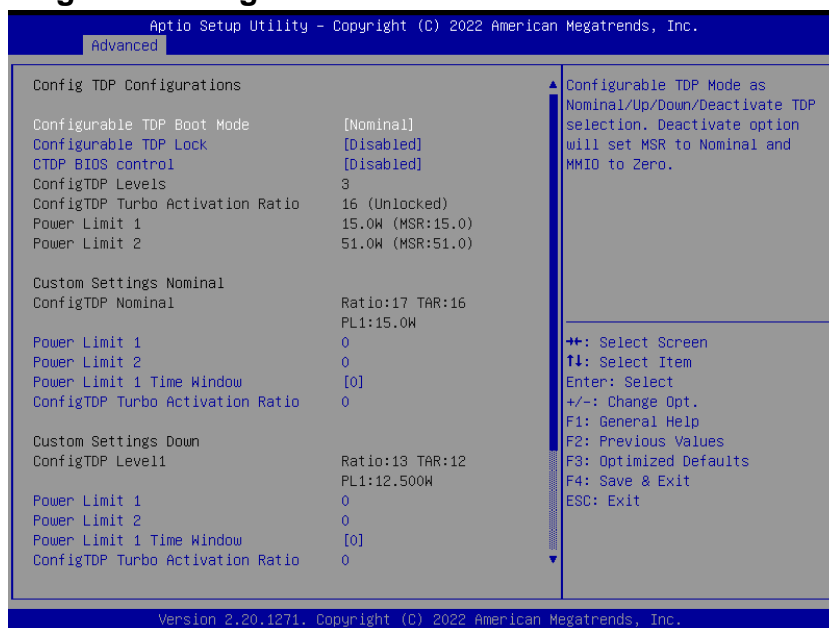

SLP-WHG-TSN

Item	Options	Description
Configurable TDP Boot Mode	Nominal[Default] Up Down Deactivate	Configurable TDP Mode as Nominal/Up/Down/Deactivate TDP selection. Deactivate option will set MSR to Nominal and MMIO to Zero.
Configurable TDP Lock	Enabled, Disabled[Default]	Configurable TDP Mode Lock sets the Lock bits on TURBO_ACTIVATION_RATIO and CONFIG_TDP_CONTROL. Note: When CTD Lock is enabled Custom ConfigTDP Count will be forced to 1 and Custom ConfigTDP Boot Index will be forced to 0.
CTDP BIOS control	Enabled, Disabled[Default]	Enables CTD control via runtime ACPI BIOS methods. This "BIOS only" feature does not require EC or driver support.
Power Limit 1	0	Power Limit 1 in values from MMIO
Power Limit 2	0	Power Limit 1 in values from MMIO
Power Limit 1 Time Window	0[Default] 1/2/3/4/5/6/7/8/10/ 12/14/16/20/24/28/ 32/40/48/56/64/80/ 96/112/128	Power Limit 1 Time Window value in seconds. The value may vary from 0 to 128. 0 = use default value (28 sec). Defines time window which TDP value should be maintained.
ConfigTDP Turbo Activation Ratio	0	Custom value for Turbo Activation Ratio. Needs to be configured with valid values from LFM to Max Turbo. 0 means don't use custom value.

3.6.2.2.2 GT - Power Management Control

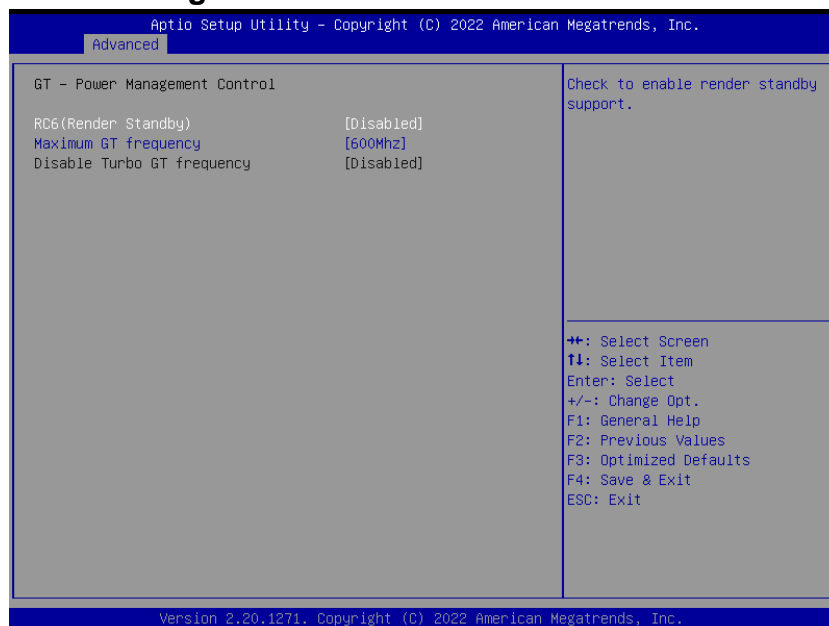

Item	Options	Description
RC6(Render Standby)	Disabled[Default], Enabled	Check to enable render standby support.
Maximum GT frequency	Default Max Frequency[Default] 100Mhz/150Mhz/200Mhz/ 250Mhz/300Mhz/350Mhz/ 400Mhz/450Mhz/500Mhz/ 550Mhz/600Mhz/650Mhz/ 700Mhz/750Mhz/800Mhz/ 850Mhz/900Mhz/950Mhz/ 1000Mhz/1050Mhz/1100Mhz/ 1150Mhz/1200Mhz	Auto Updated
Disable Turbo GT frequency	Enabled, Disabled[Default]	Enabled: Disables Turbo GT frequency. Disabled GT frequency is not limited

3.6.2.3 PCH-FW Configuration

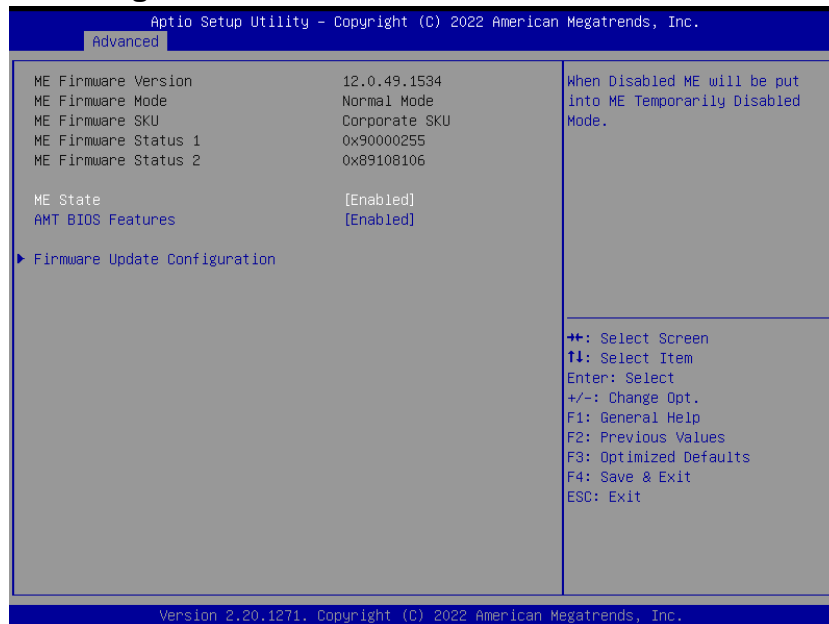

Item	Options	Description
ME State	Disabled, Enabled[Default]	When Disabled ME will be put into ME Temporarily Disabled Mode.
AMT BIOS Features	Disabled, Enabled[Default]	When disabled AMT BIOS Features are no longer supported and user is no longer able to access MEBx Setup. Note: This option does not disable Manageability Features in FW.

3.6.2.3.1 Firmware Update Configuration

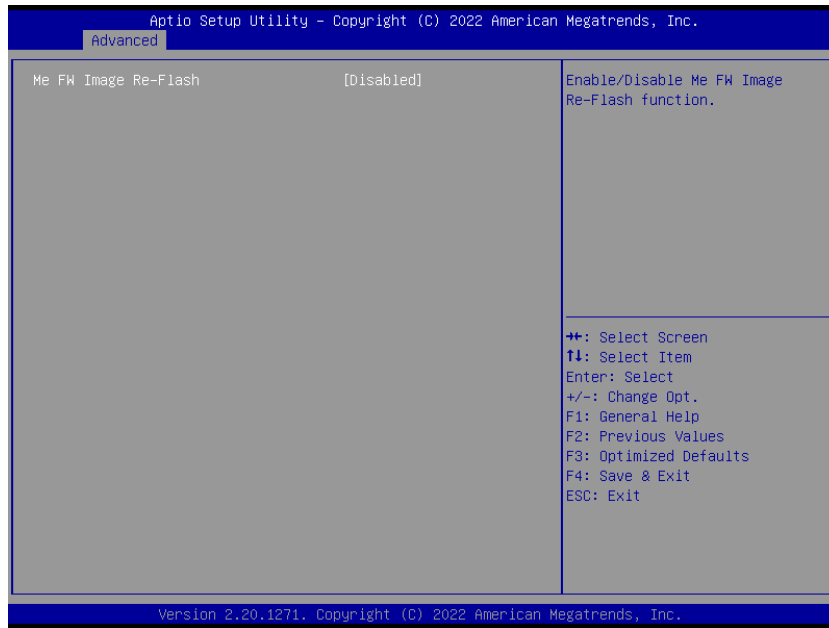

Item	Options	Description
Me FW Image Re-Flash	Disabled[Default], Enabled	Enable/Disable Me FW Image Re-Flash function.

3.6.2.4 Trusted Computing

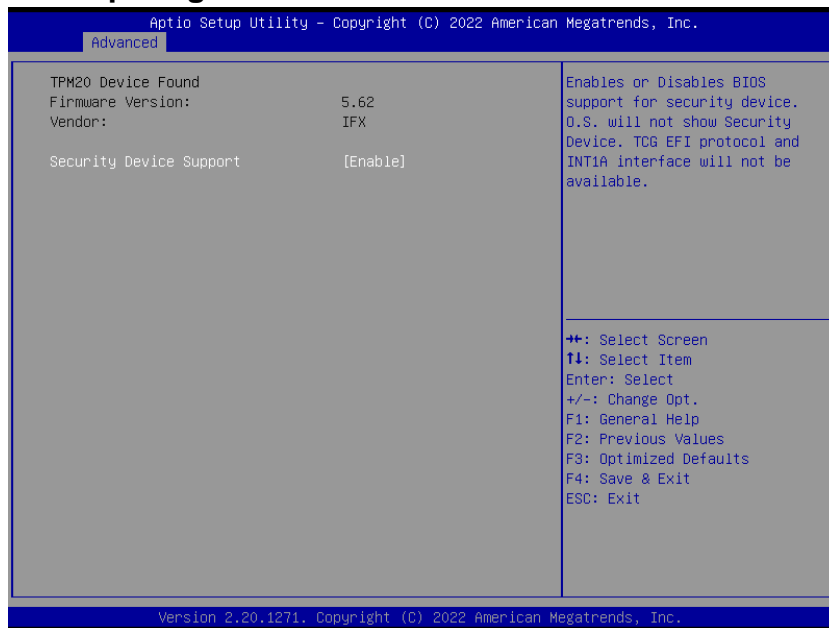

Item	Options	Description
Security Device Support	Disable, Enable[Default]	Enable or Disable BIOS support for security device. O.S. will not show Security Device. TCG EFI protocol and INT1A interface will not be available.

3.6.2.5 ACPI Settings

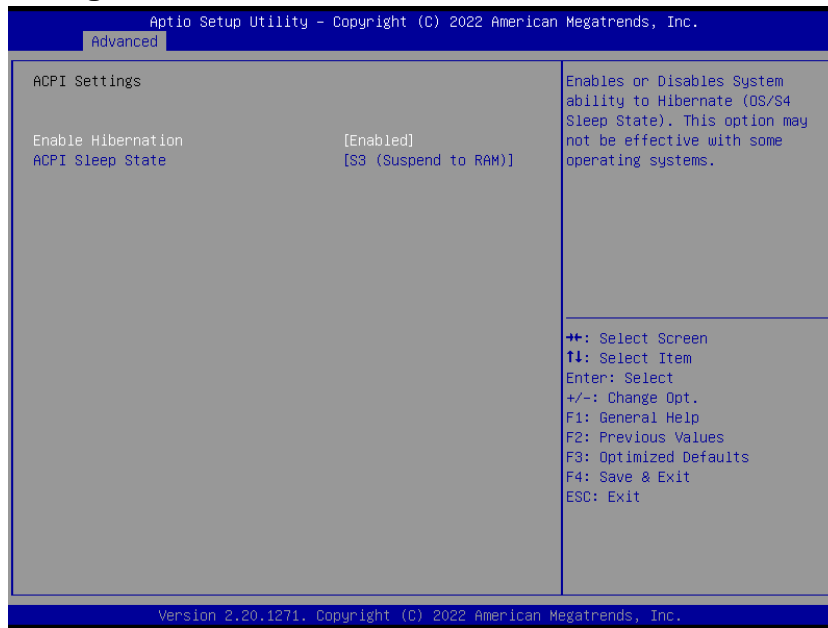

Item	Options	Description
Enable Hibernation	Disabled Enabled[Default],	Enables or Disables System ability to Hibernate (OS/S4 Sleep State). This option may be not effective with some operating systems.
ACPI Sleep State	Suspend Disabled, S3 (Suspend to RAM)[Default]	Select the highest ACPI sleep state the system will enter when the SUSPEND button is pressed.

3.6.2.6 IT8528 Super IO Configuration

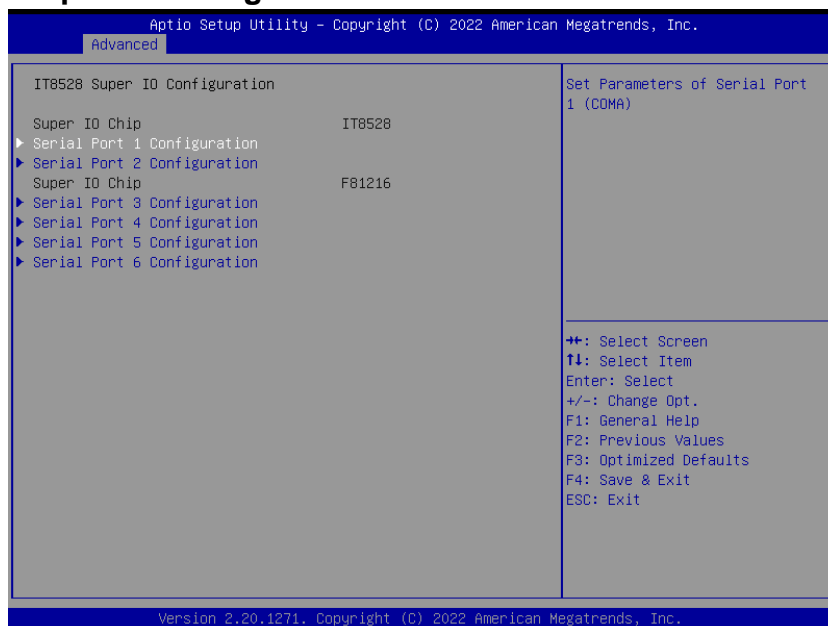

SLP-WHG-TSN

Item	Description
Serial Port 1 Configuration	Set Parameters of Serial Port 1 (COMA).
Serial Port 2 Configuration	Set Parameters of Serial Port 2 (COMB).
Serial Port 3 Configuration	Set Parameters of Serial Port 3 (COMC).
Serial Port 4 Configuration	Set Parameters of Serial Port 4 (COMD).
Serial Port 5 Configuration	Set Parameters of Serial Port 5 (COME).
Serial Port 6 Configuration	Set Parameters of Serial Port 6 (COMF).

3.6.2.6.1 Serial Port 1 Configuration

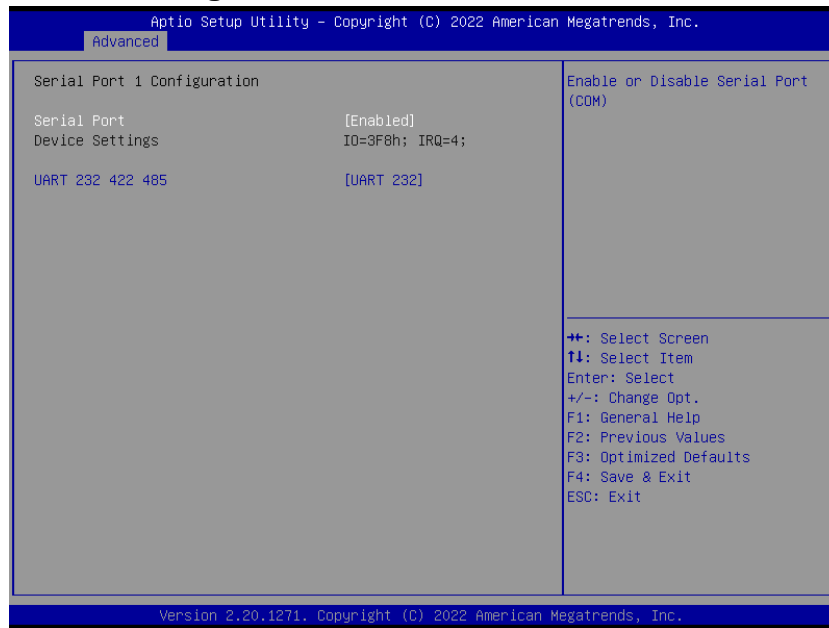

Item	Option	Description
Serial Port	Disabled Enabled[Default],	Enable or Disable Serial Port (COM).
UART 232 422 485	UART 232[Default], UART 422, UART 485	Change the Serial Port as RS232/422/485.

3.6.2.6.2 Serial Port 2 Configuration



Item	Option	Description
Serial Port	Disabled Enabled[Default],	Enable or Disable Serial Port (COM).
UART 232 422 485	UART 232[Default], UART 422, UART 485	Change the Serial Port as RS232/422/485.

3.6.2.6.3 Serial Port 3 Configuration



Item	Option	Description
Serial Port	Disabled Enabled[Default],	Enable or Disable Serial Port (COM).

3.6.2.6.4 Serial Port 4 Configuration



Item	Option	Description
Serial Port	Disabled Enabled[Default],	Enable or Disable Serial Port (COM).

3.6.2.6.5 Serial Port 5 Configuration

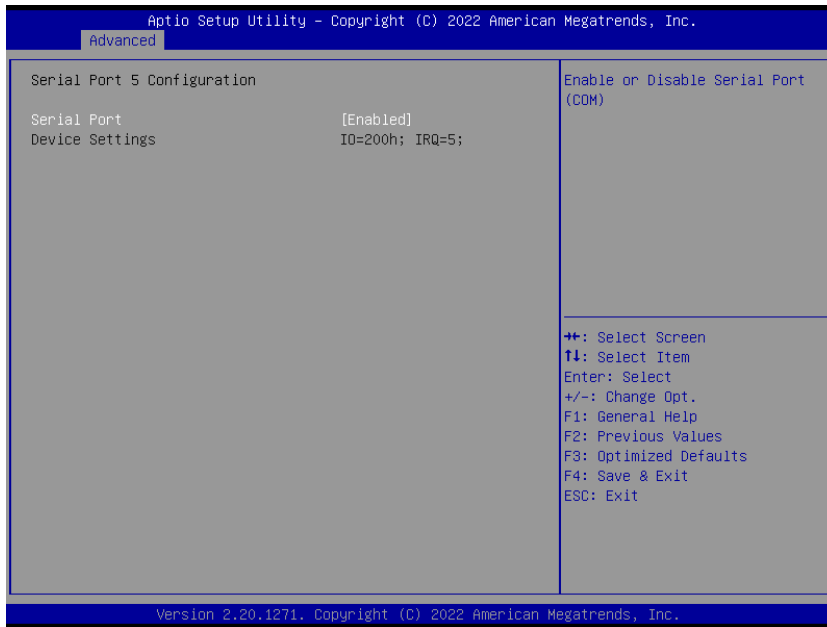

Item	Option	Description
Serial Port	Disabled Enabled[Default],	Enable or Disable Serial Port (COM).

3.6.2.6.6 Serial Port 6 Configuration

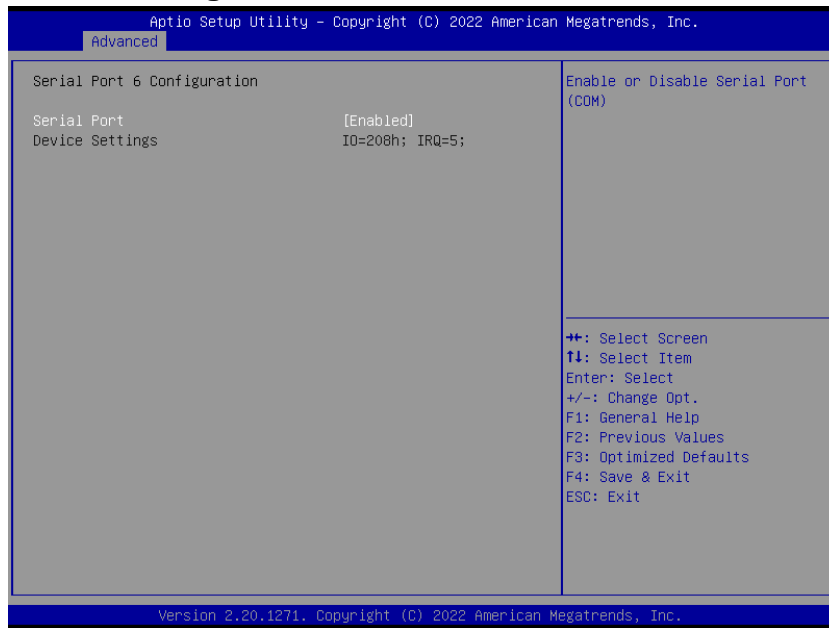

Item	Option	Description
Serial Port	Disabled Enabled[Default],	Enable or Disable Serial Port (COM).

3.6.2.7 EC 8528 HW monitor

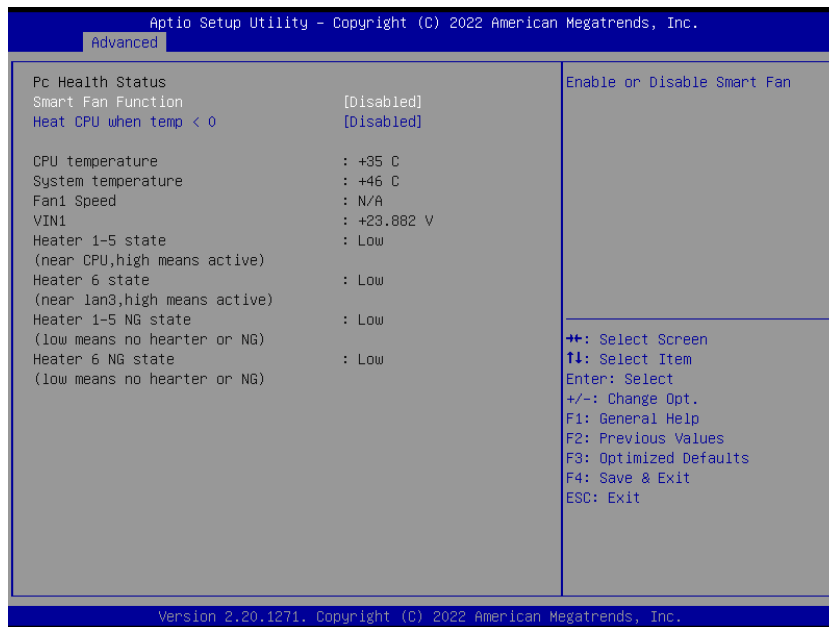

Item	Options	Description
Smart Fan Function	Disabled[Default], Enabled	Enabled or Disable Smart Fan
Heat CPU when temp < 0	Disabled[Default], Enabled	Turn on heater when CPU temperature below 0degree C before system boot up.

3.6.2.8 S5 RTC Wake Settings

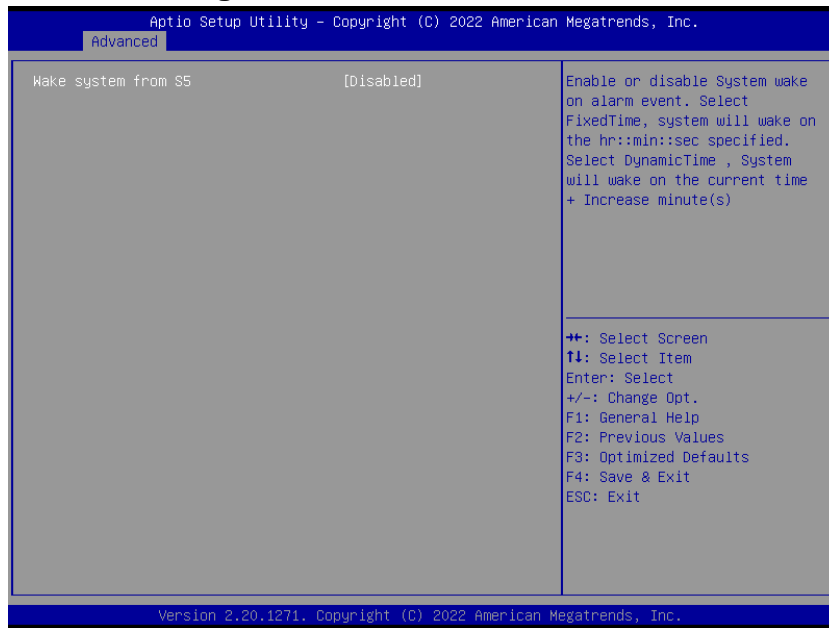

Item	Options	Description
Wake system from S5	Disabled[Default], Fixed Time Dynamic Time	Enabled or disable System wake on alarm event. Select Fixed Time, system will wake on the hr::min::sec specified. Select Dynamic Time, System will wake on the current time + Increase minute(s)

3.6.2.9 Serial Port Console Redirection

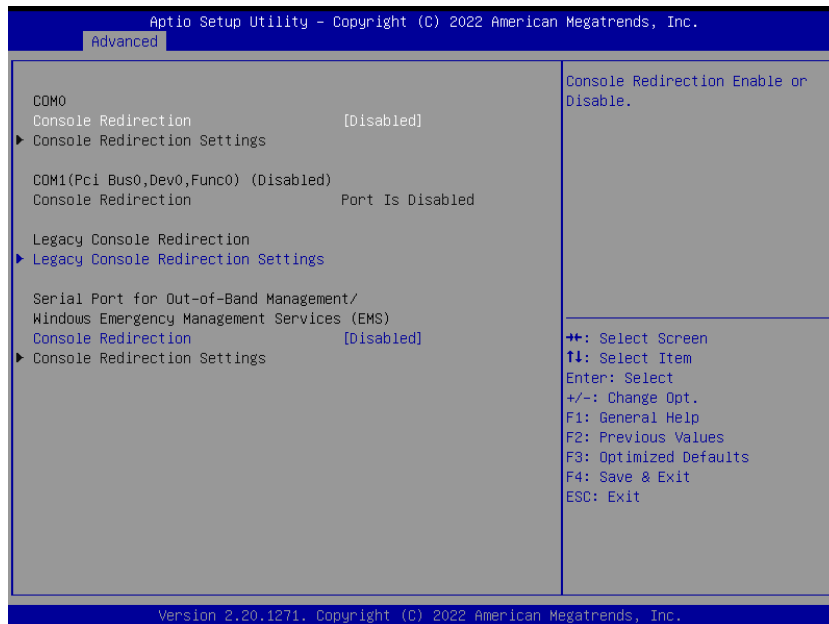

Item	Option	Description
Console Redirection	Disabled[Default], Enabled	Console Redirection Enabled or Disable.

3.6.2.9.1 Legacy Serial Redirection Port

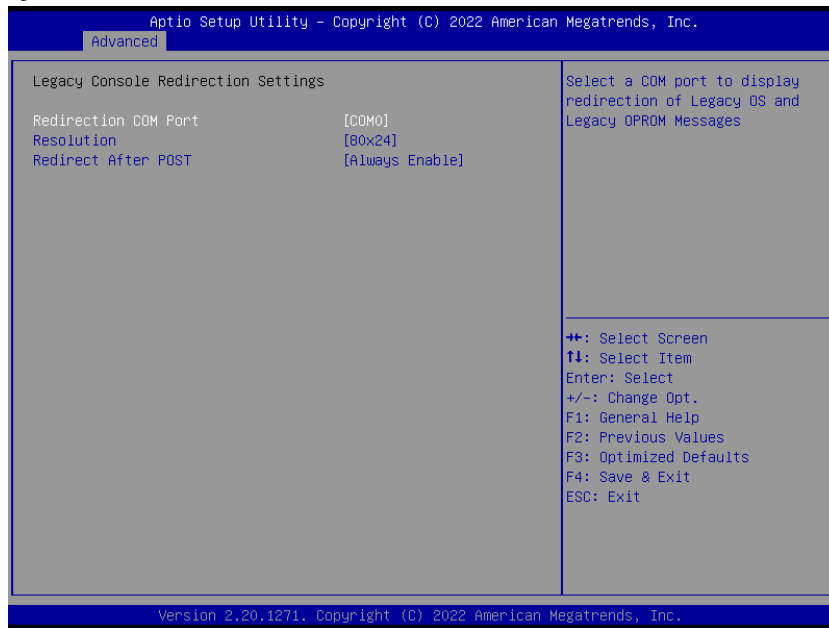

Item	Option	Description
Redirection COM Port	COM0	Select a COM port to display redirection of Legacy OS and Legacy OPRDM Messages
Resolution	80x24[Default], 80x25	On Legacy Os, the Number of Rows and Columns supported redirection
Redirect After POST	Always Enable[Default], BootLoader	When Bootloader is selected, then Legacy Console Redirection is disabled before booting to legacy OS. When Always Enable is selected, then Legacy Console Redirection is enabled for legacy OS. Default setting for this option is set to Always Enable.

3.6.2.10 USB Configuration

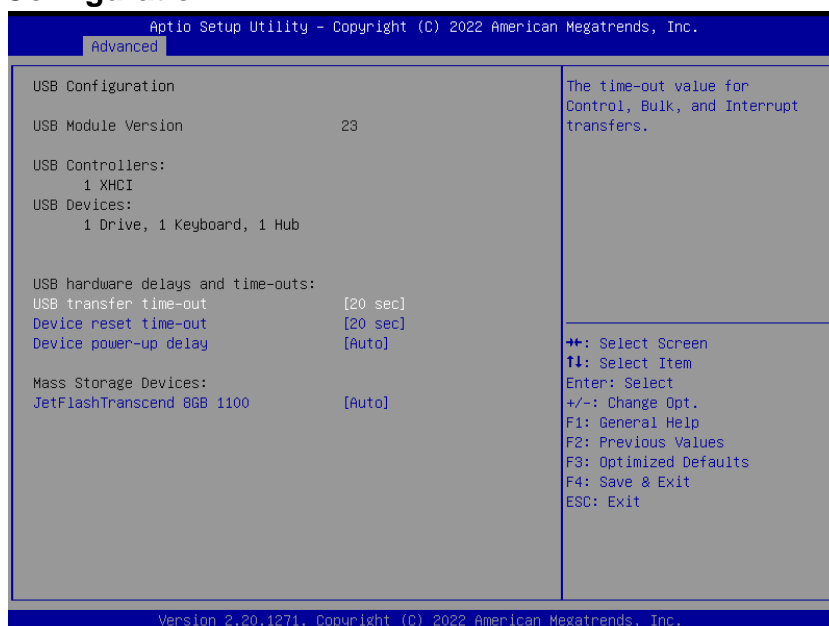

SLP-WHG-TSN

Item	Options	Description
USB transfer time-out	1 sec 5 sec 10 sec 20 sec[Default]	The time-out value for Control, Bulk, and Interrupt transfers.
Device reset time-out	10 sec 20 sec[Default] 30 sec 40 sec	USB mass storage device Start Unit command time-out.
Device power-up delay	Auto[Default] Manual	Maximum time the device will take before it properly reports itself to the Host Controller. 'Auto' uses default value: for a Root port it is 100ms, for a Hub port the delay is taken form Hub descriptor.
JetFlashTranscend 8GB 1100	Auto[Default] Floppy Forced FDD Hard Disk CD-ROM	Mass storage device emulation type. 'AUTO' enumerates devices according to their media format. Optical drives are emulated as 'CDROM', drive with no media will be emulated according to a drive type.

3.6.2.11 NVMe controller and Drive information

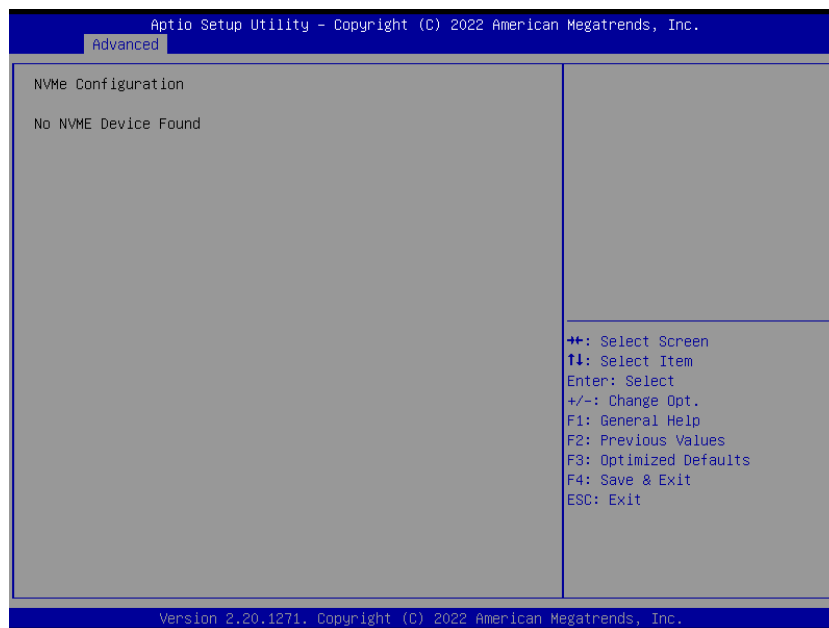

3.6.2.12 Network Stack Configuration



3.6.3 Chipset

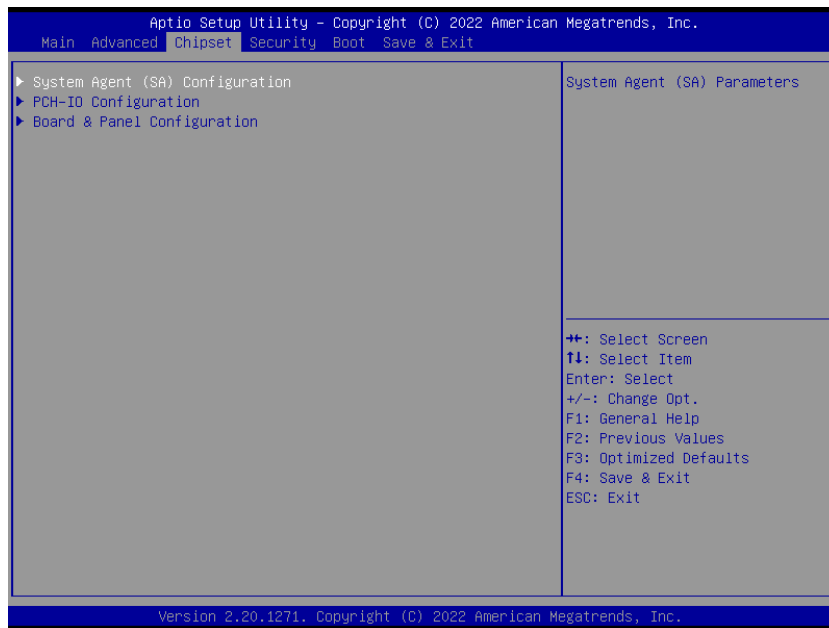

3.6.3.1 System Agent (SA) Configuration



Item	Option	Description
VT-d	Disabled Enabled[Default]	VT-d capability.

3.6.3.1.1 Memory Configuration

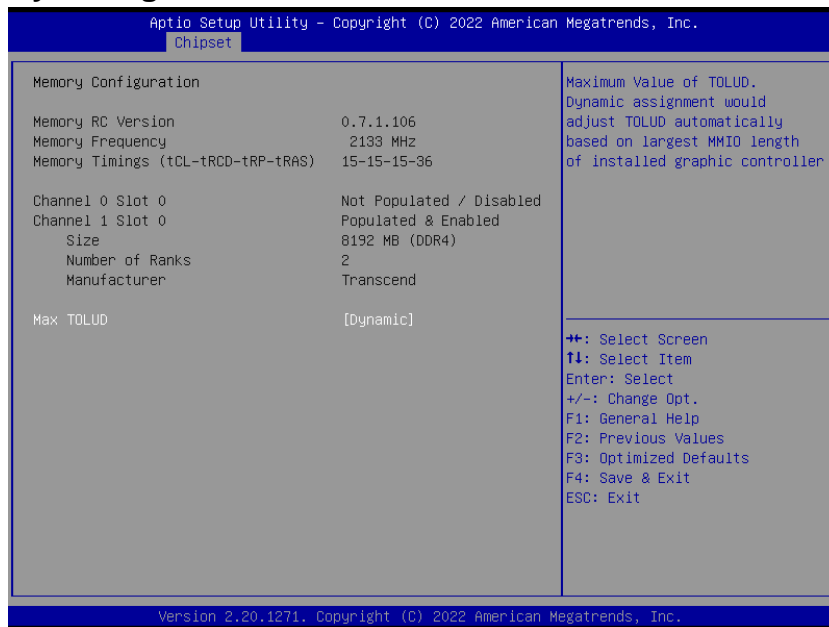

Item	Option	Description
Max TOLUD	Dynamic[Default]/ 1GB/1.25GB/1.5GB/ 1.75 GB/2 GB/2.25 GB/ 2.5 GB/2.75 GB/3 GB	Maximum Value of TOLUD. Dynamic assignment would adjust TOLUD automatically based on largest MMIO length of installed graphic controller

3.6.3.1.2 Graphics Configuration

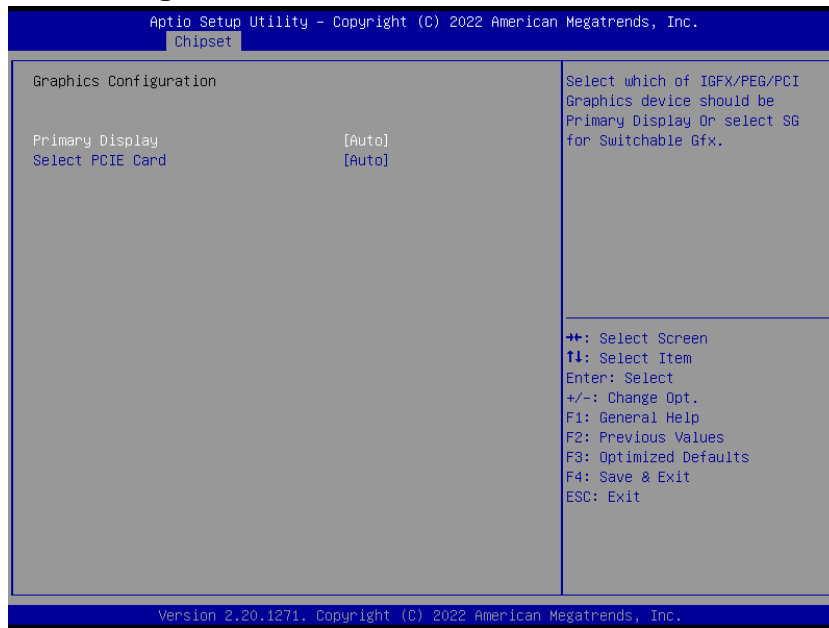

Item	Option	Description
Primary Display	Auto[Default]/ IGFX/PEG/PCI/SG	Select which of IGFX/PEG/PCI Graphics device should be Primary Display Or select SG for Switchable Gfx.
Select PCIE Card	Auto[Default] Elk Creek 4 PEG Eval	Select the card used on the platform Auto: Skip GPIO based Power Enable to dGPU Elk Creek 4: DGPU Power Enable = ActiveLow PEG Eval: DGPU Power Enable = ActiveHigh

3.6.3.2 PCH-IO Configuration

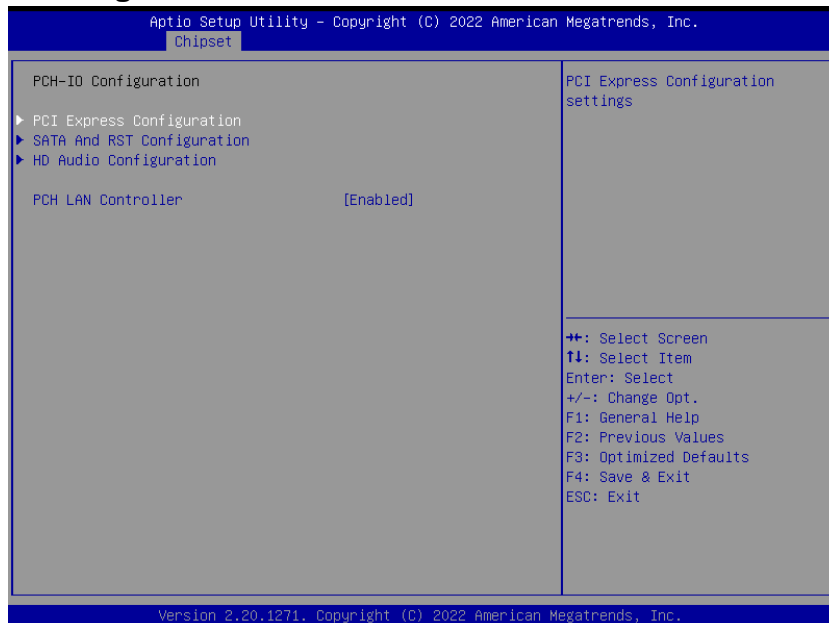

SLP-WHG-TSN

Item	Option	Description
PCH LAN Controller	Enabled[Default] Disabled	Enable/Disable onboard NIC.

3.6.3.2.1 PCI Express Configuration

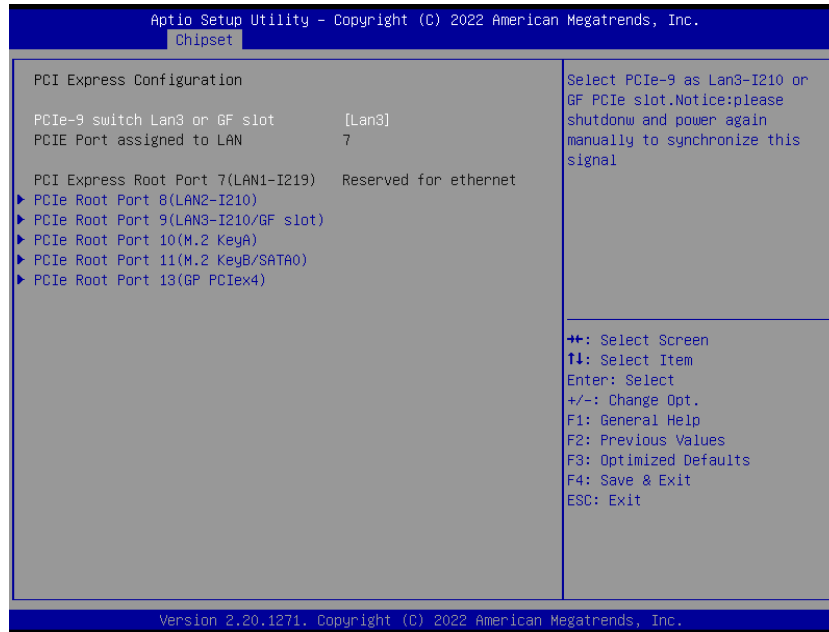

Item	Option	Description
PCIe-9 switch Lan3 or GF slot	Lan3 [Default] GF slot	Select PCIe-9 as Lan3-1210 or GF PCIe slot Notice:please shutdown and power again manually to synchronize this signal

3.6.3.2.1.1 PCIe Root Port 8(LAN2-I210)



Item	Option	Description
PCIe Root Port 8 (LAN2-I210)	Disabled Enabled[Default],	Control the PCI Express Root Port.
ASPM 7	Disabled[Default] L0s L1 L0sL1 Auto,	Set the ASPM Level: Force L0s - Force all links to L0s State AUTO - BIOS auto configure DISABLE - Disables ASPM.
L1 Substates	Disabled L1.1 L1.1 & L1.2[Default],	PCI Express L1 Substates settings.
PCIe Speed	Auto[Default] Gen1 Gen2 Gen3	Configure PCIe speed.

3.6.3.2.1.2 PCIe Root Port 9(LAN3-I210/GF slot)

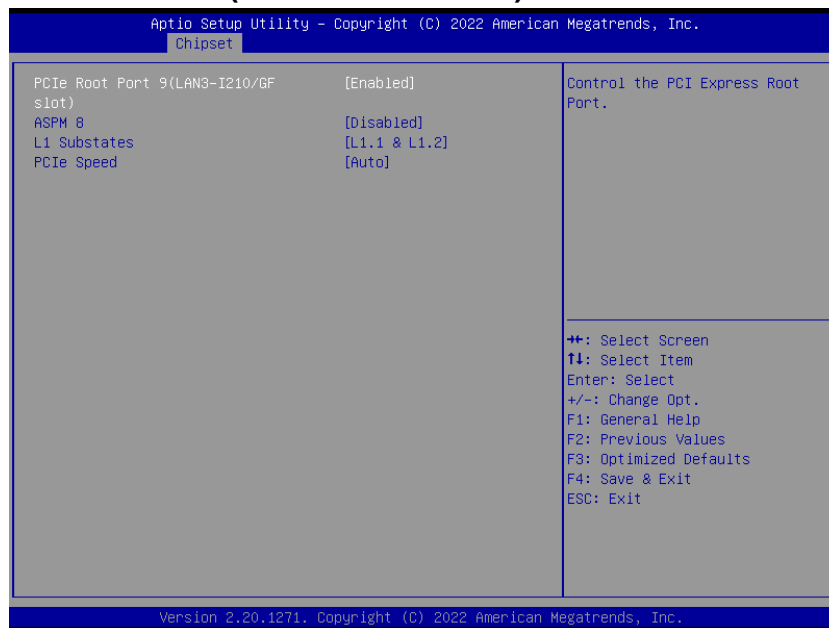

Item	Option	Description
PCIe Root Port 9 (LAN3-I210/GF slot)	Disabled Enabled[Default],	Control the PCI Express Root Port.
ASPM 8	Disabled[Default] L0s L1 L0sL1 Auto,	Set the ASPM Level: Force L0s - Force all links to L0s State AUTO - BIOS auto configure DISABLE - Disables ASPM.
L1 Substates	Disabled L1.1 L1.1 & L1.2[Default],	PCI Express L1 Substates settings.

SLP-WHG-TSN

PCIe Speed	Auto[Default] Gen1 Gen2 Gen3	Configure PCIe speed.
-------------------	--	-----------------------

3.6.3.2.1.3 PCIe Root Port 10(M.2 KeyA)

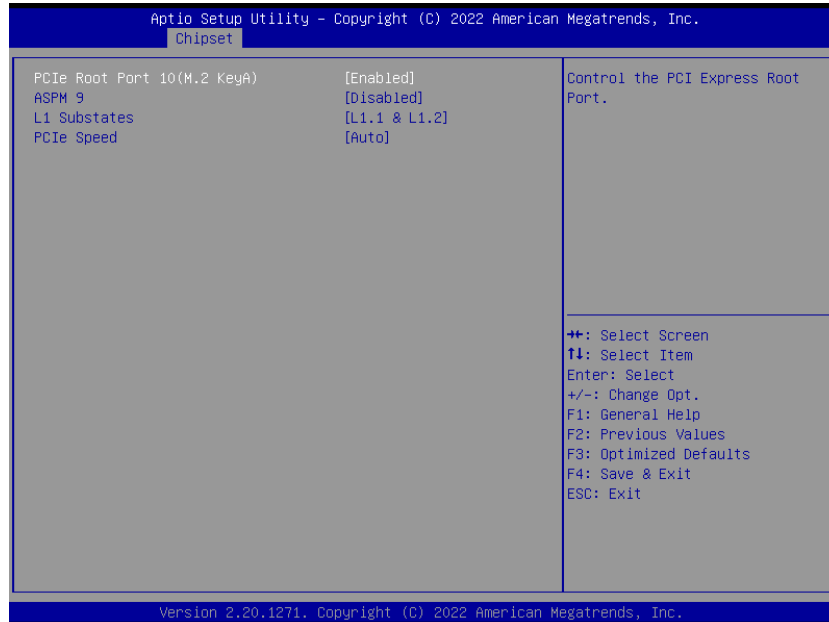

Item	Option	Description
PCIe Root Port 10 (M.2 KeyA)	Disabled Enabled [Default] ,	Control the PCI Express Root Port.
ASPM 9	Disabled [Default] L0s L1 L0sL1 Auto,	Set the ASPM Level: Force L0s - Force all links to L0s State AUTO - BIOS auto configure DISABLE - Disables ASPM.
L1 Substates	Disabled L1.1 L1.1 & L1.2 [Default] ,	PCI Express L1 Substates settings.
PCIe Speed	Auto [Default] Gen1 Gen2 Gen3	Configure PCIe speed.

3.6.3.2.1.4 PCIe Root Port 11(M.2 KeyB/SATA0)

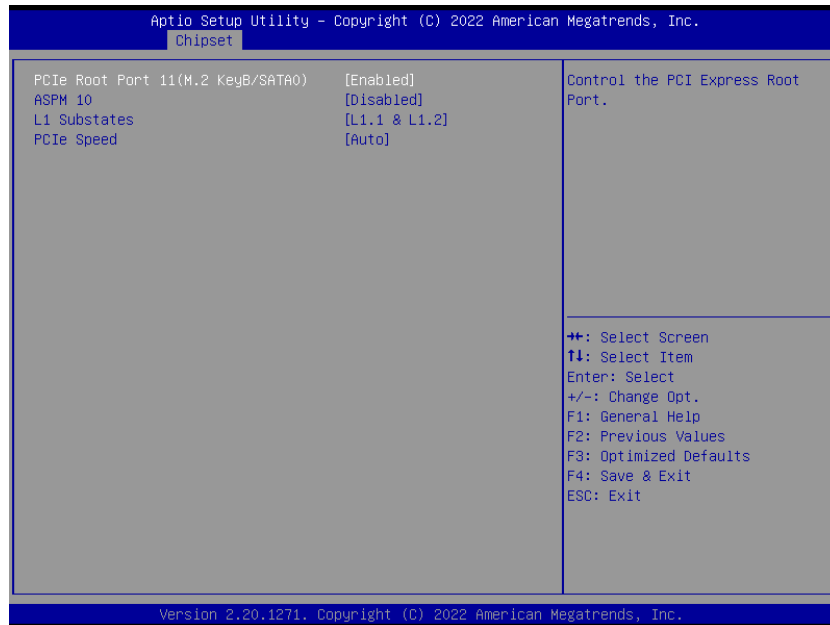

Item	Option	Description
PCIe Root Port 11 (M.2 KeyB/SATA0)	Disabled Enabled[Default],	Control the PCI Express Root Port.
ASPM 10	Disabled[Default] L0s L1 L0sL1 Auto,	Set the ASPM Level: Force L0s - Force all links to L0s State AUTO - BIOS auto configure DISABLE - Disables ASPM.
L1 Substates	Disabled L1.1 L1.1 & L1.2[Default],	PCI Express L1 Substates settings.
PCIe Speed	Auto[Default] Gen1 Gen2 Gen3	Configure PCIe speed.

3.6.3.2.1.5 PCIe Root Port 13(GP PCIe4)

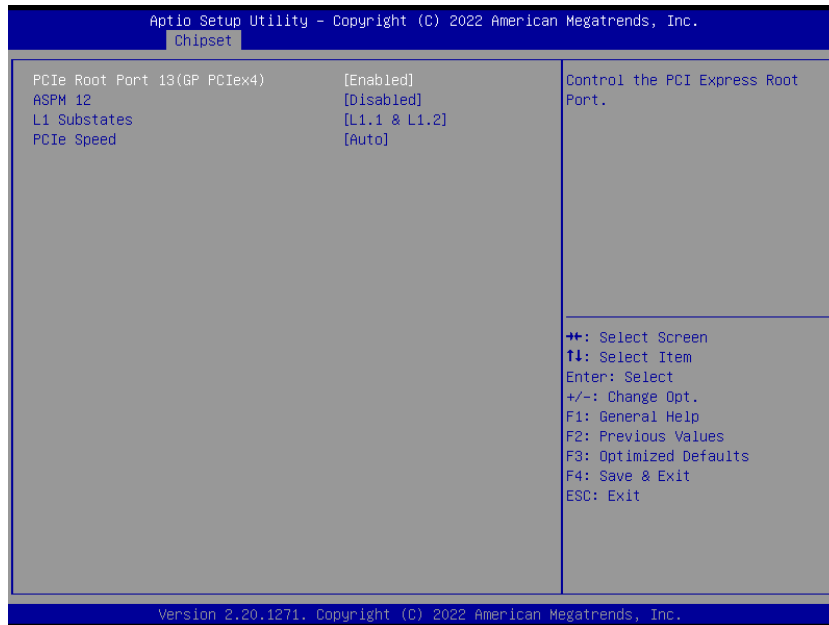

Item	Option	Description
PCIe Root Port 13 (GP PCIe4)	Disabled Enabled[Default],	Control the PCI Express Root Port.
ASPM 12	Disabled[Default] L0s L1 L0sL1 Auto,	Set the ASPM Level: Force L0s - Force all links to L0s State AUTO - BIOS auto configure DISABLE - Disables ASPM.
L1 Substates	Disabled L1.1 L1.1 & L1.2[Default],	PCI Express L1 Substates settings.
PCIe Speed	Auto[Default] Gen1 Gen2 Gen3	Configure PCIe speed.

3.6.3.2.2 SATA And RST Configuration

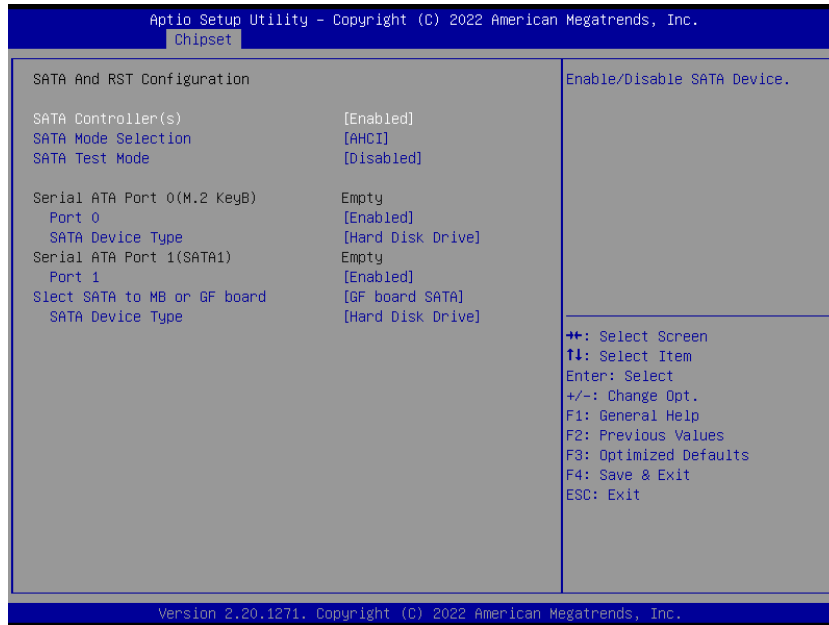

Item	Options	Description
SATA Controller(s)	Enabled[Default] Disabled,	Enable/Disable SATA Device.
SATA Mode Selection	AHCI[Default] RAID	Determines how SATA controller(s) operate.
SATA Test Mode	Enabled Disabled[Default],	Test Mode Enable/Disable (Loop Back).
Port0	Disabled, Enabled[Default]	Enable or Disable SATA Port.
SATA Device Type	Hard Disk Drive Solid State Drive[Default]	Identify the SATA port is connected to Solid State Drive or Hard Disk Drive.
Port1	Disabled, Enabled[Default]	Enable or Disable SATA Port.
Select SATA to MB or GF board	GF board SATA[Default] MB SATA	Select SATA to MB or GF board
SATA Device Type	Hard Disk Drive[Default] Solid State Drive	Identify the SATA port is connected to Solid State Drive or Hard Disk Drive.

3.6.3.2.3 HD Audio Configuration

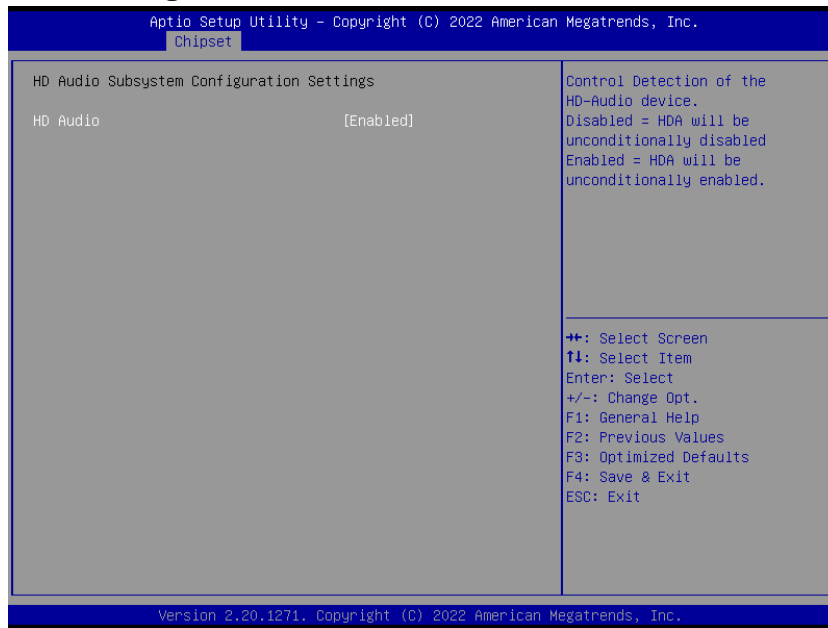

Item	Option	Description
HD Audio	Disabled Enabled[Default],	Control Detection of the HD-Audio device. Disabled = HDA will be unconditionally disabled Enabled = HDA will be unconditionally enabled.

3.6.3.3 Board & Panel Configuration

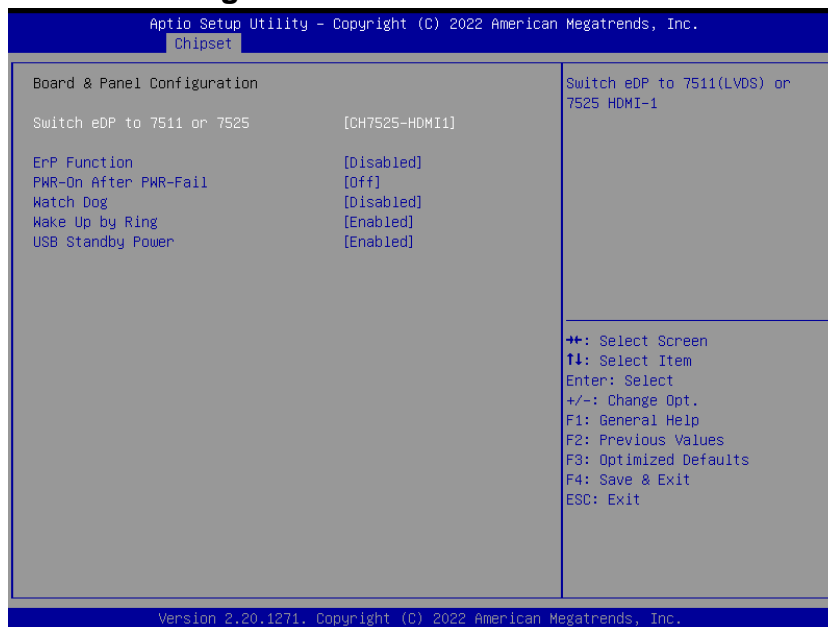

Item	Option	Description
Switch eDP to 7511 or 7525	CH7511-LVDS CH7525-HDMI1[Default]	Switch eDP to 7511(LVDS) or 7525 HDMI-1
ErP Function	Disabled[Default], Enabled	ErP Function (Deep S5).
PWR-On After PWR-Fail	Off[Default], On Last State	AC loss resume.
Watch Dog	Disabled[Default],/ 30 sec/40 sec/50 sec/ 1 min/2 min/10 min/ 30 min	Select WatchDog
Wake Up by Ring	Disabled Enabled[Default],	Wake Up by Ring from S3/S4/S5
USB Standby Power	Disabled Enabled[Default],	Enabled/Disabled USB Standby Power during S3/S4/S5

3.6.4 Security

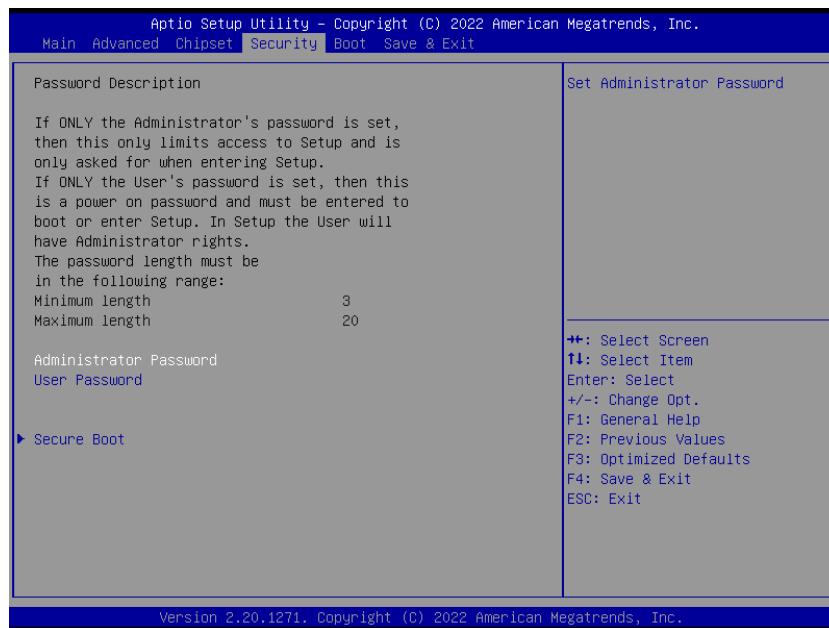

- **Administrator Password**

Set Administrator Password

- **User Password**

Set User Password

3.6.4.1 Secure Boot



Item	Option	Description
Secure Boot	Disabled Enabled[Default],	Secure Boot feature is Active if Secure Boot is Enabled, Platform Key(PK) is enrolled and the System is in User mode. The mode change requires platform reset
Secure Boot Mode	Standard Custom[Default],	Secure Boot mode options: Standard or Custom. In Custom mode, Secure Boot Policy variables can be configured by a physically present user without full authentication

3.6.4.1.1 Restore Factory Keys

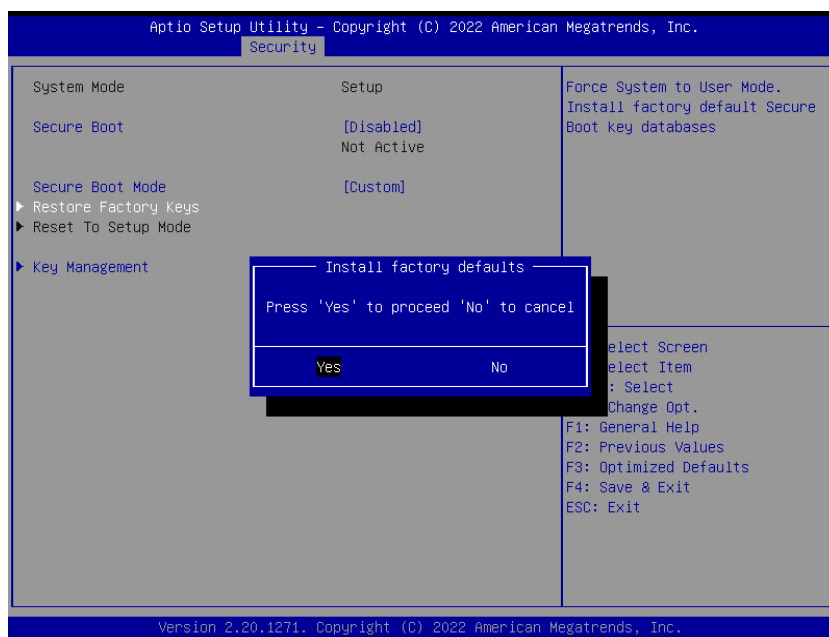

3.6.4.1.2 Reset To Setup Mode



3.6.4.1.3 Key Management

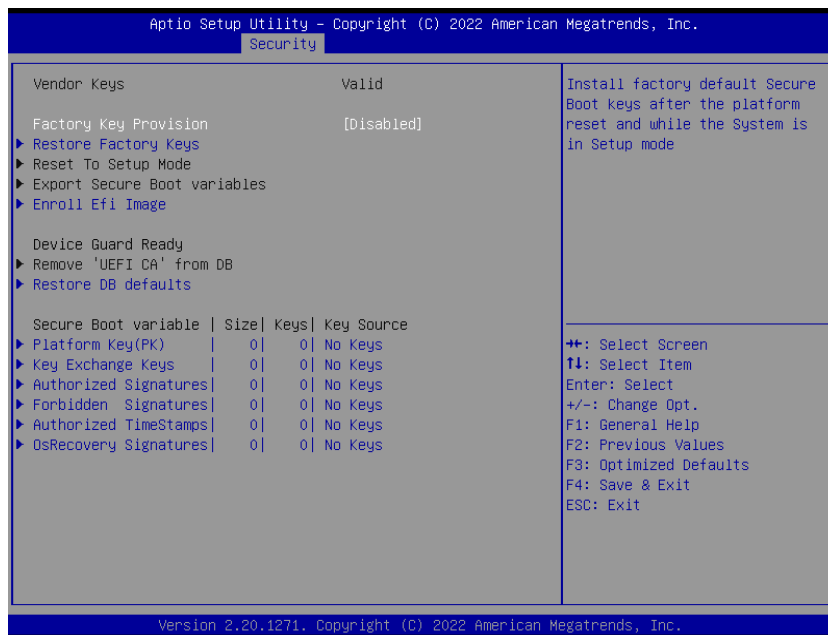

Item	Option	Description
Factory Key Provision	Disabled[Default] Enabled	Install factory default Secure Boot keys after the platform reset and while the System is in Setup mode

3.6.5 Boot

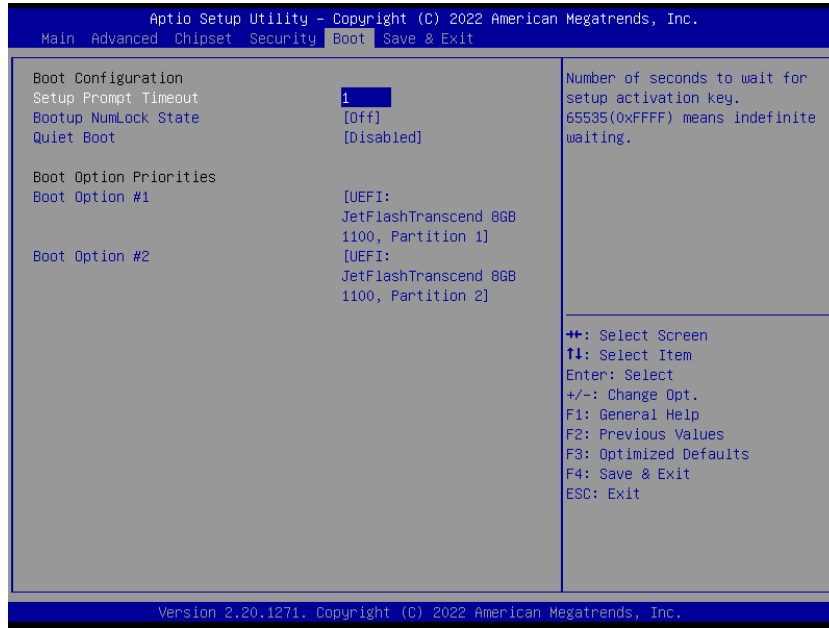

Item	Option	Description
Setup Prompt Timeout	1	Number of seconds to wait for setup activation key. 65535(0xFFFF) means indefinite waiting.
Bootup NumLock State	On Off[Default]	Select the Keyboard NumLock state
Quiet Boot	Disabled[Default] Enabled	Enables or disables Quiet Boot option
Boot Option #1	Sets the system boot order.	
Boot Option #2	Sets the system boot order.	

3.6.6 Save and Exit

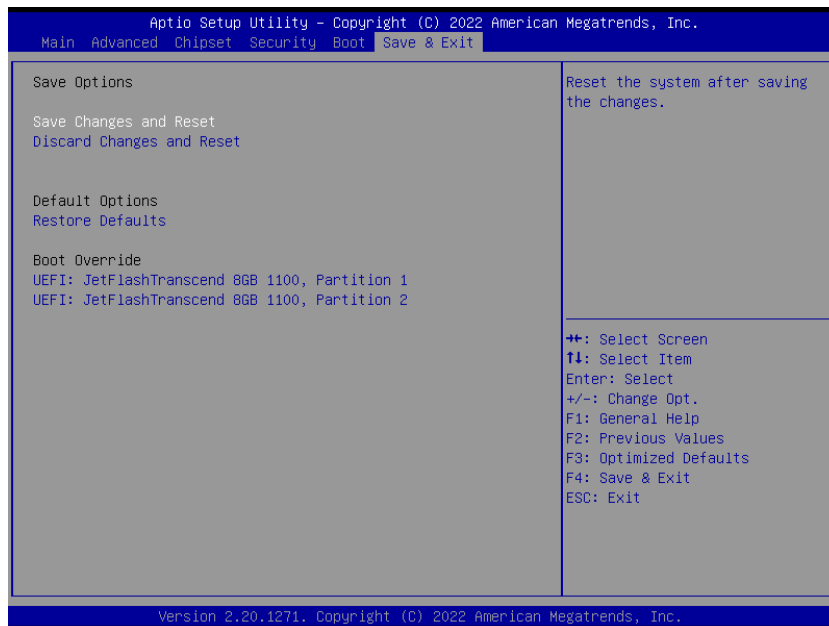

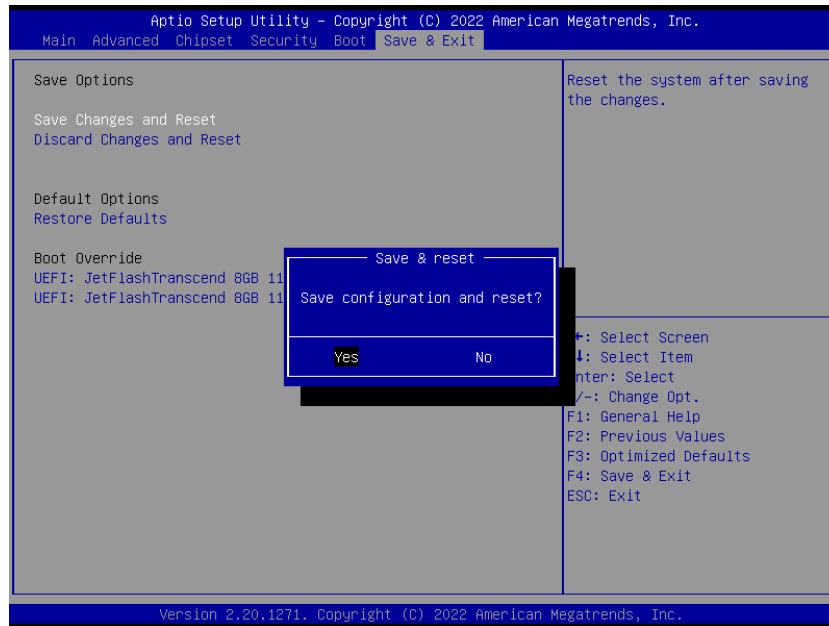

3.6.6.1 Save Changes and Reset

Reset the system after saving the changes.

3.6.6.2 Discard Changes and Reset

Reset system setup without saving any changes.

3.6.6.3 Restore Defaults

Restore/Load Default values for all the setup options.

3.6.6.4 Launch EFI Shell from filesystem device

Attempts to Launch EFI Shell application (Shell.efi) from one of the available filesystem devices.

